

SAGOLA 

20

**INDUSTRIAL PAINTING
PROFESSIONAL EQUIPMENT**



SAGOLA
65
ANNIVERSARY
1955-2020

SAGOLA 

SAGOLA can trace its origins to the year 1955 and is fruit of the pioneering spirit of its founder, Alejandro Sánchez Larrauri. It began as a small subcontracting workshop for industry. After some years in the subcontracting sector, Larrauri felt the need to manufacture his own product and progressively withdraw from subcontracted activity.

The chosen product was the spray gun. This new era for SAGOLA was crowned by the manufacture and sale of the mythical ALM 401 spray gun. From that very moment SAGOLA began to make and distribute a large number of spray gun models and other complements used in the coatings sector such as air filters, pressure pots, and an endless list of equipment for the most varied applications.

Due once again to the entrepreneurial spirit of the SAGOLA team, the need was felt to open the company to the international market. For that reason the Company began operating in related markets such as Latin America, where it soon became the indisputable leader, later expanding to Arab countries, Asia and finally Europe. Today, SAGOLA is present in more than 80 countries worldwide.

SAGOLA has maintained the highest quality standards in the manufacture of its products from its very beginnings, which has contributed to become a very important competitor in sectors such as bodyshop and industry.

Today, after 65 years, SAGOLA is still a 100% family company, a vital reason why it is a dynamic company able to adapt rapidly to changing market situations.

Nowadays SAGOLA is much more than a manufacturer of spray guns and has become a group of companies also engaged in the manufacture of aeronautic components and components for the bio-medicine sector.

Main Index

Catalogue 2020

COMPANY
Page 5/10

**INDUSTRIAL AND
CONSTRUCTION
PUMPS**
Page 11/30

**INDUSTRIAL
PRESSURE POTS**
Page 31/38

**AEROGRAPHIC
SPRAY GUNS**
Page 39/46

**AUTOMATIC
SPRAY GUNS**
Page 47/54

**INDUSTRIAL AIR
FILTRATION
SYSTEMS**
Page 55/60

**COMPRESSED AIR
COMPLEMENTS**
Page 61/65

**GENERAL
APPLICATION
GUNS**
Page 66/68

SANDING SYSTEM
Page 69

**PERSONAL
PROTECTION & WASTE
MANAGEMENT SYSTEM**
Page 70/72

**GUIDES, SPARE PARTS
AND ACCESSORIES**
Page 73/83

Background | Innovation | Services | Sectors | Customers | Standards |

Low pressure pumps | Pressure Spray guns • Low pressure pumps accessories | Pneumatic mix pump | Bellows pumps | Mix Spray guns • Aircaps and accessories for mix spray guns | Pneumatic airless pump | Electric airless pump | Airless Spray guns • Aircaps and accessories for airless spray guns | Industrial turbines |

Upper outlet pots | Lower outlet pots | Hose for pressure pots | Pneumatic mixers | Pumps and fluid supply system | Recipient lids |

4100 Xtreme Suction | 3300 GTO Suction | Classic Pro Suction | 3300 New Press | 4100 Xtreme Gravity | Mini Xtreme Gravity | 3300 GTO | Classic Pro XD Gravity | 475 XTech |

V4 | V5 HVLP | V6 EPA | V7/MIX | MiniV | Versions and applications Serie V | 450 A HVLP | 4041 | 4200 A EPA | 4098 | 4041 Mix | PSAA 108 |

5000X range filters | 4000 range filters | Plus range filters | Air quality test equipment | Accessories and spare parts |

Quick couplings and connectors | Compressed Air Hoses |

Adhesives pressure | Classic S1 Blowguns | Pneumatic undercoating guns | 3900 Plus sealers |

"L" range Sanders | Sander complements |

Face Mask 4240 | MP300 Mask | FFP2 Masks | Classic MP2 Mask | Antiestatic Overall | Can Crushers |

Aircaps and accessories for airless/mix spray guns | Filters and accessories. Pump maintenance | Spray gun accessories | Spray gun aircaps | Nozzles and Needles for Spray Guns |

Company

Since our beginnings, SAGOLA has always maintained the highest quality standards in its products and production processes, facilitating the most demanding coating processes.

SAGOLA began 65 years ago as a small subcontracting workshop with three workers. A strong desire to develop our own product and brand led SAGOLA to begin the manufacture of spray painting equipment.





Development and Innovation

We have 65 years of experience as manufacturer of SPRAY GUNS and spraying equipment

Market Observation and Analysis



SAGOLA specialises in the design and manufacture of coating systems

Strengthening our human resources is SAGOLA's principal objective

The high level of technology in our production methods guarantees the highest product quality standards

Since our beginnings, SAGOLA has always maintained the highest quality standards in its products and production processes, facilitating the most demanding coating processes.

SAGOLA began 65 years ago as a small subcontracting workshop with three workers. A strong desire to develop our own product and brand led SAGOLA to begin the manufacture of spray painting equipment.

- > Achieve the best technical conditions in order to offer the highest quality in the finished product,
- > and at the same time present innovation in our most demanding markets, such as the bodyshop and industrial sectors,...

All of this has made SAGOLA what it is today, a company and a brand recognised not only in the domestic market, but in more than 80 countries worldwide.

Experience

After 65 years making and developing new products, we are convinced of the need to establish a close relation with our clients on a day-to-day basis.

We know that the best product is based on the proper development of what is demanded by the market at each moment in time. For that reason we constantly reinforce our training and sales and marketing personnel, which is in permanent contact with the market and its needs all over the world.

The quality of our products is acknowledged in more than eighty countries. SAGOLA has a vast experience and owns know-how in the manufacture of professional coating systems.

Human Resources

After many years of work SAGOLA can call upon an extensive team of experts who believe in quality and innovation. These two factors are and will continue to be the pillars on which our brand is built.

SAGOLA is a worldwide benchmark brand thanks to the highly qualified professionals in our team. Notwithstanding, this team continues to work towards the objective of consolidating the SAGOLA brand as the industry yardstick.



Means of Production

The fusion of manufacturing, production means and manufacturing processes technologies with a highly qualified workforce has characterized SAGOLA from the very beginning.



**Qualifications and
 Commitment**

**Optimisation and
 Self-improvement**

Quality as a Trademark



R+D+i

Our commitment to R+D+i is absolutely clear. We devote all our efforts in this department to assuring that our products are adapted to the needs of the market.

Our objective is that between both parties and the innovations generated at our headquarters, clients will regard SAGOLA as a safe bet and stay loyal to a brand which researches on a day-to-day basis to develop products which answer their needs.

Services

When it comes to service we are talking about a deeply rooted culture arising from the history of SAGOLA, to which service is vital.

The robotic automation of all our warehouses is an example, a major investment which gives us an advantage over the competition when it comes to offering a fast, reliable response which the market appreciates.

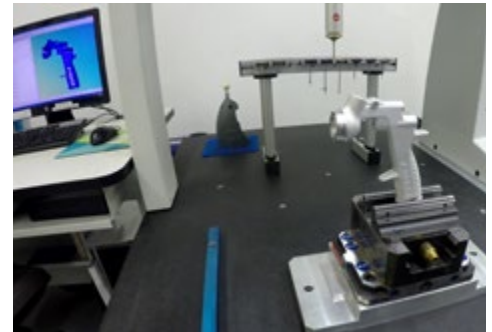

Quality

If the SAGOLA brand plays an important role on the market after 65 years of history, this is due to the emphasis placed on QUALITY.

At our factory in Vitoria (Spain), each department you visit is steeped in an atmosphere of quality.

At the beginning the founder, Alejandro Sánchez, was able to transmit this vital concept and 65 years later his heritage on this point remains as vital as on the first day.

Warranty

SAGOLA provides a 3-year guarantee with the main products. We know this is the best way of showing our customers that we believe in our products and that our guarantee will make our past and present customers loyal in the future.





From its very beginnings SAGOLA has showed marked interest in advances related to care of and respect for the environment



Support for sales networks
Our commercial office and training team are amongst the pillars of the SAGOLA BRAND worldwide



The Environment

Since the very first developments regarding VOC emissions to the atmosphere, SAGOLA wanted to be a cutting-edge company by implementing new environmental regulations and systems for its products.

With the inclusion of EPA and HVLP systems, as well as progress made in the field of filtration and others, we believe that we can contribute on a daily basis through new developments in our innovation policy.

Training

Our training team and the entire company believes that there is an important difference between being merely a quality manufacturer and being a manufacturer which develops and trains workgroups for the various sectors in which we are present.



Sales and Marketing

We believe that the products we make always need a solid sales support. Our commercial partners all over the world appreciate our assistance in setting up their sales networks and technical teams.

Thanks to the efforts of both, we embark upon each new financial year resting on a solid base suitable for the construction of a long-term project. Courses are available both at our Vitoria headquarters and on site.

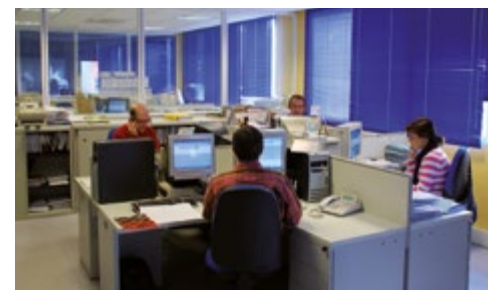

Customer Service

This department is aware that our sales effort requires its support when responding to particular dilemmas, problems or needs related to specific queries we are constantly receiving from all over the world. These are transmitted rapidly to qualified experts who provide immediate data and solutions.

**An answer
to every need**

Leading brand

**We have different
product lines specifically
adapted to the
needs of each sector**



*Bodyshop,
we set the pace*

The sectors in which we have traditionally had a presence, have always considered us a leading brand, but to stay that way all the players in each sector demand that our developments take account of the changes taking place in each field. We therefore have different product lines for each segment in accordance with its needs.

Bodyshop

This is the sector most often identified with SAGOLA, and in many ways the sector which sets the standard for all the others as far as paints and performance are concerned.

Apart from our list of annexes, for this sector we detail our star products in quality and sales volume.



Industrial Vehicle

This sector recognises in SAGOLA an established manufacturer of coating spray guns and equipment. The brand is closely associated with reliability, quality and convenience at work, contributing confidence to the commercial vehicle distribution network.

Industrial Supplies

This is a constantly developing sector in which SAGOLA has always been the reference, with special finishes, equipment, for pressure and special pumps for products specifically developed for this sector.

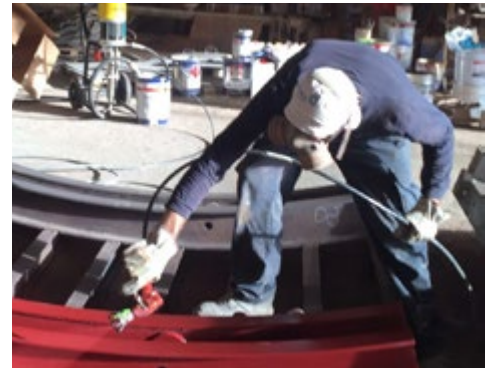

*Industrial Supplies,
a traditional benchmark*

International Expansion

Since August 2011, Sagola boasts a new distribution center in Mexico, which is 100% property of Sagola. This distribution center commercialize the whole range of Sagola products in Mexico.

Likewise, in 2019 the second Latin American distribution center was opened in the capital of Colombia, Bogotá.

SAGOLA MEXICO



The loyalty of our users is one of our closest allies, in conjunction with innovation

SAGOLA has always been export-oriented and has achieved a notable expansion

Market oriented



Devoted to continuous improvement in quality, service and management

Committed to the Environment



ATEX Ex II 2 GX

Intellectual property and brand

Trademark in more than 80 countries



Our business partners are aware that SAGOLA, as well as contributing a quality brand, provides them with a manufacturer who has won their loyalty by dint of constant effort over the years. This is something we strive for every day.

We are aware that our development and innovation will be our best allies along with the loyalty of our users in the future.

Client Portfolio

We have always had an export-oriented attitude. We are currently present in more than 80 countries and keep on growing to ensure that our brand, and the products it represents, reach the entire world with the invaluable help and support of our importers.

More than 60 industrial patents/models registered worldwide CEE / ASIA / USA

- Manual spray guns
- Automatic spray guns
- Packing nuts
- Blowguns
- Aircaps
- Velves
- Deposits
- Keys, Accessories

As a reference it is worth noting that SAGOLA was one of the first companies in Spain to obtain ISO certification, which meant a new management model where improvisation was forgotten and gave way to a management organization fully controlled and automated.

The commitment to the environment by SAGOLA has always been one of its main objectives. This is the reason why SAGOLA has been a pioneer in the manufacture of equipment for low-emission paint solvent to the atmosphere. We were pioneers in meeting environmental regulations as strict as the 1151 of the US California State SCAQMD.

On the other hand the commitment to uphold the highest standards of security makes the manufacture of our products to evolution continuously in its design and manufacturing process.

Therefore our standard products meet CE, ATEX, IP54, etc.

SAGOLA is a company which spends significant resources in R+D and is always in constant evolution. As result of this investigation and due to the need of protection of our own Know-how, SAGOLA is very active in all related with the intellectual property, being owner of a large number of patents worldwide.

Undoubtedly, SAGOLA is a recognized brand worldwide so in this aspect, the protection levels of our brand worldwide are very high. SAGOLA has got registered its different brands (SAGOLA, DEFYNIK and DELON) practically worldwide.



Approved Manufacturers

Our relationship with painting manufacturers around the world means that launching SAGOLA in a new market is easier for us.

Our homologations make the market more active because users know that the product they are buying has been tested and homologated by their paint brand.

For many years, SAGOLA has devoted all its efforts not only on improving the quality of its products and service, but also to improve all aspects related with management, HR, environment, etc.

Industrial and Construction Pumps

Wide range of equipment for painting:

- > **Low Pressure Pumps** for spray guns.
- > **Airless Pumps** for airless spray gun operation.
 - > **Mix Pumps**
- > **Fluid supply of Liquids**; paints, solvents, oils...

Adapted to all industrial sector needs for spray painting:

- > **Mid to high continuous production** by automatic machinery and paint robots.
- > **Metal, wood, tannery, plastics, vehicles and industrial machinery sectors.**

Maximum resistance to all types of solvents and designed for the new waterborne paints and clearcoats.

The range of industrial pumps offered by SAGOLA adheres to our most demanding principles of quality in the materials employed and precision machining to produce technologically functional and robust pumps suitable for all types of paint.



INDUSTRIAL PAINTING
Industrial Pumps
 Low pressure
 Pneumatics

DM 1/400



DM
1/400

High production
 Several spray guns
 Low pressure painting
 equipment

Twin Double Membrane Pump.

Painting equipment for high productions. It has been designed and manufactured focusing on the needs of several trades: from small metal, plastic and wood-working factories to the highest level industrial bodyshops.

It can be used with several spray guns at once.

Easy-to-use and low air-consumption combined with the highest performance.

Low maintenance cost.

There is a special version for abrasives.

Clearcoats, dyes, clears, ceramics, basecoats and glues. Basecoats, primers and, in general, medium viscosity products.

ATEX II 2 GX



***Full equipment (standard),**
 includes DM 1/400 (Trolley and absorption),
 4100 Xtreme Pressure 1.20 (XT01 B) and 5 m. air
 and product hose (Ø 6mm. inside).

TECHNICAL DETAILS

- > Pressure ratio 1 : 1
- > Free flow: 40 L/min.
- > Product output pressure: max. 7 bar.
- > Air inlet pressure: max. 7 bar.
- > Air consumption: 580 L/min.
- > Weight: 18 kg.
- > Air inlet: BSP 1/4"
- > Product outlet: BSP 3/8"



Code	Version
30920401	Trolley and absorption
30920402	Trolley and deposit
30920403	Trolley and absorption (abrasives)
30920404	Trolley and absorption (Double outlet product)
30920406	Wall and absorption
30920407	Wall and deposit
30920499	*Full equipment



DM 1/400 detail
 Double outlet product
 Code 30920404





DM 1/300 and DM 2K

DM
1/300

Medium production

High precision

ATEX  II 2 GX

30 L Double Membrane Pump.

Medium production. For finish and primers.

High precision product regulator.

Anti-pulsation system and double paint filter.

Lacquers, clearcoats, basecoats, enamels.

Medium viscosity products.



**Full equipment (standard), includes DM 1/300 (Trolley and absorption), 4100 Xtreme Pressure 1.20 (XT01 B) and 5 m. air and product hose (Ø 6mm. inside).*

TECHNICAL DETAILS

- > Pressure ratio 1 : 1
- > Free flow: 30 L/min
- > Air consumption: 380 L/min
- > Product output pressure: max: 6 bar
- > Air inlet pressure: max. 6 bar
- > Air inlet: BSP 1/4"
- > Product outlet: BSP 3/8"



Código	Versión
30920501	Trolley and Absorption with regulator
30920502	Trolley and Absorption without regulator
30920503	Trolley and Deposit with regulator
30920504	Trolley and Deposit without regulator
30920505	Wall and Absorption with regulator
30920506	Wall and Absorption without regulator
30920507	Wall and Deposit with regulator
30920508	Wall and Deposit without regulator
30920599	*Full equipment

DM
2K

High production

Two-component

ATEX  II 2 GX

Double diaphragm pump for two components.

Mixing ratio, 1:1

High production.

Prepared to work with medium viscosity products with solid particles.

Anti-pulsation system and double paint filter.

Ideal for application of polyesters and acrylics.



Code	Version
30920801	Trolley and Absorption

TECHNICAL DETAILS

- > Pressure ratio 1 : 1
- > Free flow: 40 L/min
- > Product output pressure: max: 7 bar
- > Air inlet pressure: max. 7 bar
- > Air consumption: 580 L/min
- > Weight: 21 kg



INDUSTRIAL PAINTING
Industrial Pumps
Pressure
spray guns

4100 Xtreme
Pressure



4100
XTREME

- New appearance, lighter and more ergonomic**
- Polished and anodized body, highly resistant**
- High profitability in continuous painting**
- New HVLP and EPA versions in the fastest model of Sagola range**
- Time and tiredness saving**
- Mist reduction**
- Solution for new generation paints, high solids, waterborne varnish and enamels**
- Maximum speed, productivity and ease of application**
- Capable to work with high paint flows**
- Air-paint single shaft**
- Paint saving with top finishes**

Wide range of applications with the support of a pressure pot or a low pressure pump. Compliance with the most demanding rules concerning solvent emission.

4100 Xtreme EPA

The most environmentally-friendly solution without losing sight of profitability or finish quality. It offers high paint transfer without increasing air consumption



Extensions

See options in page 84

or any special application requirements. Maximum gloss with the most demanding finishes.

4100 Xtreme HVLP

Maximum paint saving and solvent emission reduction. Paint transfers up to 75%, much higher than the required by regulation. Maximum paint control. Especially recommended for color, metal and dye applications. Outlet pressure of only 0.7 bar High speed aircap XT03 and special aircap 3030 for processes where the motto is minimum mist and maximum painting.

4100 Xtreme Medium Pressure

Wide range of applications, even high viscosity, with the support of a pressure pot or pressurized pump. Paint flow above 330 cc/min. and large fans.

Application possibility for all kind of paints

and sprayable products: dyes, metals, glazes, varnishes, basecoats, primers, glues, adhesives, abrasive products, ceramics, forge effect (special T.C.), textured, etc.

TECHNICAL DETAILS

- > Weight: 536 g
- > Dimensions: 20 x 18 x 4.2 cm
- > Air inlet coupling BSP 1/4" male
- > Product inlet coupling BSP 3/8" male
- > Design pressure: 8 bar
- > Maximum recommended inlet pressure (working pressure): 2.5 - 3.0 bar (Medium pressure)
- > Maximum recommended inlet pressure (working pressure): 2.0 bar (HVLP and EPA)
- > Maximum recommended application distance: 20 - 25 cm (Medium pressure)
- > Maximum recommended application distance: 15 - 20 cm (HVLP and EPA)
- > Air consumption:

Aircap 765: 370 L/min	Aircap XT01 B: 320 L/min
Aircap 777: 400 L/min	Aircap XT03: 530 L/min
Aircap 20A: 470 L/min	Aircap 3030: 570 L/min
- > Materials in contact with the product: INOX, chromed aluminium, POM, Teflon, Nylon.
- > ATEX 2 II GX

Code	Version	Application
10152109	1.00 [XT01 B]	Special metalized and basecoats
10152110	1.20 [XT01 B]	Clearcoats and primers
10152111	1.40 [XT01 B]	Primers and fillers
10152114	1.00 [SuperVIT]	Special metalized and basecoats
10152115	1.20 [SuperVIT]	Clearcoats and primers
10152117	1.40 [SuperVIT]	Primers and fillers
10152107	1.00 [XT03]	High quality finishes. Basecoats, dyes
10152108	1.20 [XT03]	General finishes. Primers
10152112	1.20 [3030]	Minimum mist. Industrial finishes
10152113	1.40 [3030]	Minimum mist. Primers, basecoats
10152104	1.00 [777]	Maximum speed
10152105	1.20 [777]	Finishes, high gloss
10152101	1.00 [765]	High quality finishes
10152102	1.20 [765]	General finishes. Primers
10152103	1.40 [765]	Primers, basecoats
10152106	1.80 [20A]	Glues, adhesives

*ASK FOR special nozzles up to 2.80 mm and Tungsten Carbide combinations.



**4100 Xtreme Ceramic
and 4100 Xtreme PD**



**4100
XTREME
CERAMIC**

Nozzle and Needle in
Tungsten Carbide

Anodised aluminium aircaps
(corrosion free)

Trigger and axle made in
Stainless steel

Ideal for high microns jobs and
and highly abrasive products

High flow air valve "SOFT
FLOW" Ideal for work at high
pressures

TECHNICAL DETAILS

- > Weight: 552 g
- > Dimensions: 20 x 19 x 4,2 cm
- > Product inlet: 3/8" M BSP
- > Air inlet: 1/4" M BSP
- > Design pressure: 10 bar
- > Maximum recommended inlet pressure
(working pressure): 4 bar
- > Air consumption 1.4[78]/2.5[64]/2.8[62]: 410 L/min
Aircap 2.2[64]: 390 L/min 1.8[67]: 400 L/min
Aircap XT03: 460 L/min 2.8[63C]: 450 L/min
- > Materials in contact with product: Stainless Steel, POM,
Teflón, Nylon and Tungsten Carbide .
- > ATEX II 2 GX



Applications: Toiletes, Roof tiles, Kitchen
equipment, Plates, Tiles, Engobe, Ceramic
enamels, Vitrified enamels, Structural
anticorrosive treatment, etc.



Ideal for marking paints, road markings, primers,
high thickness, waterproofing, intumescent, soil
protection, generally dense products,...

TECHNICAL DETAILS

- > Weight: 552 g
- > Dimensions: 20 x 19 x 4.2 cm
- > Product inlet: 3/4" M BSP
- > Air inlet: 1/4" M BSP
- > Design pressure: 8 bar
- > Maximum recommended inlet pressure
(working pressure): 3 bar
- > Air consumption (2 bar inlet): 147 L/min
- > Average sound pressure level: 80 dB
- > Materials in contact with product:
INOX, POM, Teflon and Nylon.
- > ATEX II 2 GX



Code	Version
10152130	1.4 [78]
10152131	1.4 [XT03]
10152132	1.8 [67]
10152133	2.2 [64]
10152134	2.5 [64]
10152135	2.8 [62]
10152136	2.8 [63C]

A perfect fusion between speed and high transfer
with quality finishes of XTREME aerographic
systems.

In the ceramic applications, we provide the
maximum resistance. And in vitroceramic, we
can achieve the highest degree of refinement and
finishing quality.

**4100
XTREME PD**

Speed of application and
high transfer level (>80%)

XTREME Finish quality

Robustness

**Maximum quality of
materials**

Ideal for difficult jobs

Easy and smooth to use

Code	Version
10152301	6.0 [PD1]
20530705	*Full equipment

***Full equipment**, includes Classic 30
Inox pressure pot, 4100 Xtreme PD
and 10 m. air and product hose.



Forged and anodized body, providing great
strength and protection to corrosion both externally
and internally.

Nozzles with Internal mixing XTREME technology.
Perfect atomization. METAL TO METAL technology
where all sealings are free of joints.

INDUSTRIAL PAINTING
Industrial Pumps
Pressure
spray guns

**Mini
XTREME**

High resistance polishing
and anodizing

Specially recommended for
dyes and metalics

Ideal for line-painting

Top quality finishes

Manufactured in
forged aluminium

Perfect ergonomics

SAGOLA Xtreme system
with compact size



Extensions

See options in
page 84



High precision air-flow
regulator included.
Solvent-proof gaskets.

Mini Xtreme Pressure and 3300 GTO Pressure



Due to its size it is the
perfect spray gun
for **restricted access areas** which
require a lot of wrist movement.
It reduces mist, saves paint and
perfectly **defines the work zone.**

Adapted to the latest products. Tested
and developed with waterborne
products.

Its new MiniVIT aircap offers a high speed
application with a large fan. Designed to work at
the highest degree of atomisation at low pressures.

Code	Version	Application
10111907	0.80 [miniVIT]	Dyes and metals
10111908	1.00 [miniVIT]	Highest quality finishes
10111909	1.20 [miniVIT]	Primers, basecoats and fillers
10111904	0.80 [miniEPA]	Feathering, dyes, basecoats
10111905	1.00 [miniEPA]	Highest quality finishes
10111906	1.20 [miniEPA]	Very high speed finishes
10111901	0.80 [mini HVLV]	Especially for dyes
10111902	1.00 [mini HVLV]	Finishes, low mist
10111903	1.20 [mini HVLV]	Finishes, primers



There are no gaskets in couplings
between air and paint
Designed without O-rings
in the air system

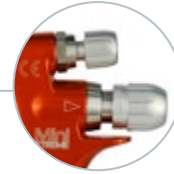

High precision aluminium **product and
fan pattern regulators** designed for easy
handling even when wearing gloves.

Numbered product regulator
for totally accurate paint control.

TECHNICAL DETAILS

- > Weight: 347 g
- > Air inlet coupling thread BSP 1/4" male
- > Paint inlet coupling thread BSP 3/8" male
- > Maximum air pressure: 8 bar
- > Maximum recommended application distance:
Mini EPA: 15 - 18 cm
Mini HVLV: 10 - 15 cm
Mini VIT: 18 cm
- > Maximum air consumption:
Mini EPA: 190 L/min
Mini HVLV: 335 L/min
Mini VIT: 375 L/min
- > Materials in contact with the product:
INOX, chromed aluminium, POM,
Teflon, Nylon.
- > ATEX 2 II GX



**3300
GTO**



New design
New forged and chrome body

High performance and
atomization

High transfer aluminium
aircaps

Light and robust

Versatile

With a light injected-aluminium
body, it is a top level product with
an excellent price/quality ratio.
High performance. High speed
application. Large size fan.
Application of enamels, varnishes,
primers and basecoats. Nozzles
and needles in stainless steel. HVLV and EPA
aircaps that comply with regulations concerning
solvent emissions.

Code	Version	Application
10152210	1.00 [HVLV]	Finishes, Dyes
10152211	1.20 [HVLV]	General finishes
10152212	1.40 [HVLV]	Primers, basecoats
10152214	1.00 [EPA]	Top quality finishes
10152215	1.20 [EPA]	General finishes
10152216	1.40 [EPA]	Primers

* ASK for special nozzles

TECHNICAL DETAILS

- > Weight: 478 g
- > Dimensions: 18 x 17.5 x 4 cm
- > Product inlet: 3/8" M BSP
- > Air inlet: 1/4" M BSP
- > Air consumption (2 bar inlet):
GTO EPA: 240 L/min
GTO HVLV: 260 L/min
- > ATEX II 2 GX





Accessories

Filter accessories pump anti-recoil

Code	Name
83660029	100-mesh DM 400 filter
83660030	60-mesh DM 400 filter

Product regulator low pressure

Code	Name
52410019	Product regulator low pressure / DM

Accessories

Code	Name
30090017	Membrane kit DM 400
30090018	Air distribution centre gasket kit DM 400
30090019	Pneumatic distribution kit DM 400
30090020	Product valve kit DM 400



Air hose. Anti-static

Code	Name
56414014	2.5 m. 6x12mm F 1/4" - F 1/4"
56414024	6 m. 8x15mm F/F 1/4"
56414025	11 m. 8x15mm F/F 1/4"
56414027	16 m. 8x15mm F/F 1/4"
56414026	26 m. 8x15mm F/F 1/4"

Anti-static Product hose

Anti-static aerographic hose for Waterborne/Solvent.
 8x16 mm. F/F 3/8"

Code	Name
56414116	6 m. 8x16mm. F/F 3/8"
56414117	11 m. 8x16mm. F/F 3/8"
56414115	16 m. 8x16mm. F/F 3/8"



Absorption filters

Code	Name
56418055	40 microns circular filter + spring
83660047	Special absorption filter for narrow pass

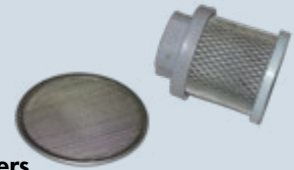

Turbines filters

Code	Name
56418597	Air filter Kit Turbo 3000 Pro (6 units)
56418663	Air filter Kit Turbo 2200 Pro (6 units)



Air + Product hoses. Aerographics

Code	Name
86463818	5 m. spray gun hose set (8 mm. + 6 mm.) HVLP
86463819	10 m. spray gun hose set (8 mm. + 6 mm.)
86463891	Adhesives. 10 m. air hose 8 mm. + 10 mm. Product hose
86463894	Dyes. 5 m. air hose 8 mm. + 3 mm. Product hose

Air hose + product hose + cover. Aerographics.

Lights. Anti-static Air hose. 8x15 mm.
 Product hose with 3/8" adapter

Code	Name
56414039	5 m. (Air hose 8x15 mm. + product hose 6x8 mm. + cover)
56414044	7,5 m. (Air hose 8x15 mm. + product hose 6x8 mm. + cover)
56414040	10 m. (Air hose 8x15 mm. + product hose 6x8 mm. + cover)
56414041	15 m. (Air hose 8x15 mm. + product hose 6x8 mm. + cover)
56414042	20 m. (Air hose 8x15 mm. + product hose 6x8 mm. + cover)



INDUSTRIAL PAINTING
Industrial Pumps
Pneumatic
Mix pump

Raider 300 Mix



Raider 300 mix
 (Trolley and deposit
 version)



***Full equipment (standard),**
 includes Raider 300 mix (Trolley and absorption),
 Mini Xtreme Mix, 5 m. product and air hoses.

RAIDER
300mix

High Production

Easy to use

Very low air consumption

Minimum maintenance

ATEX II 2 GX

SAGOLA introduces its new range of professional line RAIDER 300 MIXED version.

This line, exclusively designed and manufactured for professional use, gathers high standards both in term of performance and image.

Within the quality standards we focus on simplicity and durability.

Thus, we have redesigned completely the hydraulics. Now it contributes to a long-lasting life even in the worst working conditions and without waiving on its performance.

TECHNICAL DETAILS

- > Pressure ratio: 30:1
- > Product inlet: Ø 12 x 21 mm.
- > Product outlet: BSP 1/4"
- > Free flow (60 cycles): 1.8 L/min
- > Product output pressure: max.: 200 bar
- > Air inlet pressure max.: 7 bar
- > Max. air consumption: 370 L/min
- > Tip max: 0.013"
- > Weight: 15.5 kg



Applications

Ideal for clearcoats, waterborne products, lacques, fonds, enamels and light primers.

The mixed version raider range has been designed and manufactured focusing on the needs of medium metal and wood-working factories.

Code	Version
30951602	Trolley and absorption
30951603	Trolley and deposit
30951604	Wall and deposit
30951605	Wall and absorption
30951698	*Full equipment

Mack 150 Mix and Mack 320 Mix

MACK
150mix

High Production

ATEX  II 2 GX



Mack 150 mix
 (carro y depósito)

Mix pump. Ideal for finishes in high production, easy to use and very robust.

Reduced maintenance and self-adjusting packing system.

Clearcoats and waterborne paints, lacquers, basecoats and primers, enamels and antioxidants.

Code	Version
30931901	Trolley and absorption
30931902	Trolley and deposit
30931903	Wall and absorption
30931904	Wall and deposit
30931999	*Full equipment

TECHNICAL DETAILS

- > Pressure ratio: 15:1
- > Free flow (60 cycles): 2.7 L/min
- > Product output pressure: max.: 91 bar
- > Air inlet pressure max.: 7 bar
- > Air consumption: 245 L/min
- > Tip max: 0.018"
- > Weight: 20 kg



***Full equipment (standard),**
 includes Mack 150 mix (Trolley and absorption),
 Mini Xtreme Mix, 5 m. product and air hoses.

More information and application guides on page 82.

MACK
320mix

High Production

ATEX  II 2 GX



Pneumatic mix pump for high speed and production. Easy to use and high robust. Reduced maintenance and self-adjusting packing system.

Clearcoats and waterbase products, lacquers, fillers, primers and anti-oxidant products.

Code	Version
30932003	Trolley and absorption
30932004	Trolley and deposit
30932006	Wall and absorption
30932009	Wall and deposit
30932099	*Full equipment

TECHNICAL DETAILS

- > Pressure ratio: 32:1
- > Free flow (60 cycles): 2.7 L/min
- > Product output pressure: max.: 226 bar
- > Air inlet pressure max.: 7 bar
- > Air consumption: 610 L/min
- > Tip max: 0.018"
- > Weight: 30 kg



***Full equipment (standard),**
 includes Mack 320 mix (Trolley and absorption),
 Mini Xtreme Mix, 5 m. product and air hoses.

More information and application guides on page 82.

INDUSTRIAL PAINTING

Industrial Pumps

Mix

Bellows pumps

HTV 250

High production

Minimum maintenance

Bellow pump system (without packing-gland)

Easy to use

Very low air consumption

Ideal for the medium metal and wood working factories

ATEX  II 2 GX

Code	Version
30931801	Trolley and absorption
30931899	*Full equipment

***Full equipment (standard),** includes HTV250, Mini Xtreme Mix and 7 m. product and air hoses.

HTV 250 and HT 10/15/25

Sagola new professional range of **vertical bellows pumps**; HTV 250 mixed version.

Designed and manufactured for professional use, the HTV 250 offers excellent performance both in terms of features and design. The hydraulic components were redesigned for highest level of quality focused on technology and durability.

Thus, we have redesigned completely the hydraulics. Now it contributes to a long-lasting life even in the worst working conditions and without waiving on its performance. The bellows system provides long-lasting durability with minimum maintenance even for highly demanding materials.

TECHNICAL DETAILS

- > Pressure ratio: 25:1
- > Free flow (60 cycles): 2.8 L/min
- > Product output pressure max.: 175 bar
- > Air inlet pressure max.: 7 bar
- > Air consumption: 448 L/min
- > Maximum Tip: 0.018"
- > Weight: 30 kg



HT

10/15/25

Recommended for automatic paint lines

Continuous production

Ideal for UV products

ATEX  II 2 GX

Code	HT10
30951901	Trolley and absorption
30951902	Wall mount and absorption
30951999	*Full equipment

Code	HT15
30952001	Trolley and absorption
30952002	Wall mount and absorption
30952099	*Full equipment

Code	HT25
30952301	Trolley and absorption
30952302	Wall mount and absorption
30952399	*Full equipment

Pneumatic mix pump ideal for automatic installations. High flow bellows pump without pressure drops. With its oversized design offers a very long life and minimum maintenance. Suitable for several manual spray guns.

Lacquers, fillers, primers, enamels, clearcoats, ultraviolet and polycyclic. Generally, medium viscosity products.

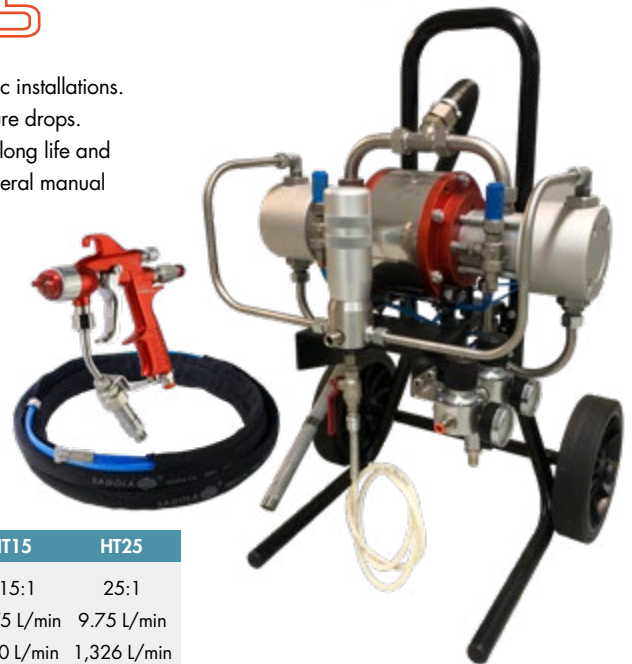

TECHNICAL DETAILS

	HT10	HT15	HT25
> Pressure ratio:	10:1	15:1	25:1
> Free flow:	9.75 L/min	9.75 L/min	9.75 L/min
> Air consumption:	646 L/min	800 L/min	1,326 L/min
> Product output pressure max.:	60 bar	90 bar	150 bar
> Air inlet pressure max.:	6 bar	6 bar	6 bar
> Weight:	41 kg	42 kg	48 kg

***Full equipment (standard),** includes HT10/15/25 (trolley and adsorption), Mini Xtreme Mix and 5 m. product and air hoses.

Recommended spray guns: V7, 4041 Mix and Xtreme Mix



Mini Xtreme Mix



Fluid filter housing
 guarantying coating quality

Swivel coupling
 avoiding tension in the fluid hose

Mini
XTREME MIX

High resistance and anodized forged aluminium body

Nozzle and Needle fittings made of Tungsten carbide

Smooth action trigger
100% Stainless steel

Exterior and interior corrosive protection

Ideal for complex jobs

Maximum ergonomics

ATEX  II 2 GX

SAGOLA presents its new spray gun where is the result of a great design work, obtaining one of the smaller and ergonomics mixed gun on the market. Ideal for painting parts with complex shapes.

A perfect fusion between speed and high transfer with quality finishes of XTREME aerographic systems.

Full control in the regulation of fan, maximum precision.

Ideal for waterborne products. Designed for UV and waterborne paints. Ideal for furniture sector, industry and industrial bodyshop.

XTREME technology nozzles

METAL TO METAL technology, free of joints



Progressive air valve
 Better control and precision

Tool-less needle disassembling system

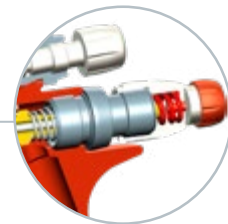

Fan regulator
 High precision

Security system
 Trigger block

TECHNICAL DETAILS

- > Max. working pressure: 200 bar
 - with yellow spring: 150 bar
 - with red spring: 200 bar
- > Air inlet: M16
- > Product inlet: 1/4"
- > Product filter: 100 mallas
- > Air consumption: 150 L/min



Code	Aircap	Air inlet	Product inlet
35130201	11/40	Quick connector 8 mm.	1/4"
35130202			Swivel coupling 1/4"
35130203		Coupling M16	1/4"
35130204			Swivel coupling 1/4"
35130205	13/40	Quick connector 8 mm.	1/4"
35130206			Swivel coupling 1/4"
35130207		Coupling M16	1/4"
35130208			Swivel coupling 1/4"

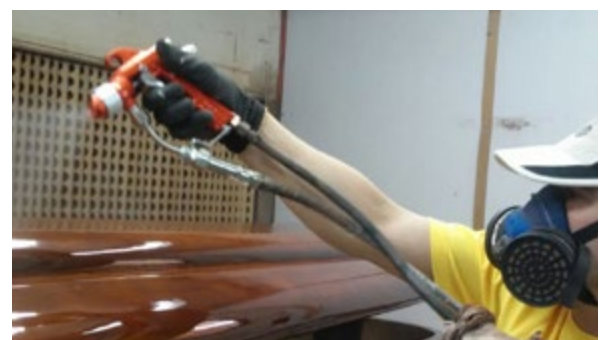

INDUSTRIAL PAINTING

Industrial Pumps

Pumps and Mix spray guns accessories

Pumps and Mix spray guns accessories

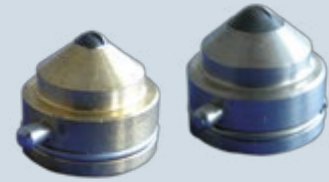

Mix aircaps (TIPS)

Application	Name	Nozzle (inch/mm)	Spray angle	Spray width (mm.) at 30 cm.	Air flow at 100 bar (L/min)	Code
Finishes	09/25 Standard - Extra Finish	0.009"/0.23	25°	140	0.25	814 605 18
	09/40 Standard - Extra Finish	0.009"/0.23	40°	178	0.25	814 605 19
	11/40 Standard - Extra Finish	0.011"/0.28	40°	190	0.37	814 605 29
	11/65 Standard - Extra Finish	0.011"/0.28	65°	254	0.37	814 605 31
Basecoats and Primers	13/40 Standard - Extra Finish	0.013"/0.33	40°		0.57	814 605 40
	13/65 Standard - Extra Finish	0.013"/0.33	65°		0.57	814 605 42
	13/80 Standard - Extra Finish	0.013"/0.33	80°		0.57	814 605 43
	15/25 Standard - Extra Finish	0.015"/0.38	25°	178	0.72	814 605 49
	15/40 Standard - Extra Finish	0.015"/0.38	40°	216	0.72	814 605 50
	15/50 Standard - Extra Finish	0.015"/0.38	50°	254	0.72	814 605 51
	15/65 Standard - Extra Finish	0.015"/0.38	65°	279	0.72	814 605 52
	15/80 Standard - Extra Finish	0.015"/0.38	80°	330	0.72	814 605 53
High speed	18/40 Standard - Extra Finish	0.018"/0.46	40°	254		814 605 75
	18/65 Standard - Extra Finish	0.018"/0.46	65°	330		814 605 77
	21/40 Standard - Extra Finish	0.021"/0.53	40°	279	1.52	814 605 90
	21/80 Standard - Extra Finish	0.021"/0.53	80°		1.52	814 605 93

- The fan size is indicative and it will vary depending on the viscosity and the pressure at which sprayed.
 - Others available nozzle and angles. Consult.

Spray gun filter



Code	Name
56418057	Filter holder Kit (1/4 - 3/8) + Mesh filter (100+60)
564 18053	Kit of 10 100-mesh spray gun filters
56418054	Kit of 10 60-mesh spray gun filters
83660037	Mix filter 100 layers
30010015	Kit of 10 microfilters mix filters

High pressure. Hose set + cover



Code	Name
86463804	5 m. (3/16" product hose + 10 mm. air hose) set + cover
86463869	7 m. (3/16" product hose + 10 mm. air hose) set + cover
86463805	10 m. (3/16" product hose + 10 mm. air hose) set + cover
86463806	15 m. (3/16" product hose + 10 mm. air hose) set + cover
56414036	7 m. (3/16" product hose + 8 mm. air hose) set + cover *
56414037	11 m. (3/16" product hose + 8 mm. air hose) set + cover *

*Quick coupling version.

Anti-recoil filters



Code	Name
83660009	100-mesh filter
83660010	60-mesh filter

Absorption Filters

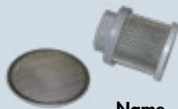

Code	Name
56418055	40 microns circular filter + spring
83660047	Special absorption filter for narrow pass

Filters and Sundry Accessories



Code	Name
83660055	High capacity filter set (1L.)
83660058	200-mesh filter
83660056	300-mesh filter
83660057	In line filter with swivel coupling, 100 mesh
30010015	Kit of 10 100-mesh micro-filters (mix aircaps)
85760301	Airless hose couplings 1/4" - 1/4"

Accessories

Code	Name
OIL	
30090099	Hydraulic Oil RENOLIN MR10 (Electric Airless)
30090098	Packing oil OILPACK (Pneumatic airless/mix)
PISTON PNEUMATIC	
84260099	Complete drain set
86465206	Complete absorption set
30090091	Complete deposit set
56418483	Raider 160/260 absorption valve set
56418542	Mack 150/320 absorption valve set
56418485	Raider 160 Lower packing set
56418498	Raider 160 Upper packing set
56418488	Raider 260 Lower packing set
56418499	Raider 260 Upper packing set
56418545	Mack 150/320 Lower packing set
56418546	Mack 150/320 Upper packing set
56418484	Complete hydraulic axis kit + Raider 160 packing kit
56418487	Complete hydraulic axis kit + Raider 260 packing kit
56418544	Mack 150/320 Complete hydraulic axis kit
56418489	Raider 160/260 Pneumatic axis kit
56418539	Mack 320 Pneumatic axis kit



Raider 300 and Mack 320

RAIDER 300

High Production

Easy to use

Very low air consumption

Minimum maintenance

ATEX  II 2 GX

Code	Version
30951602	Trolley and absorption
30951603	Trolley and deposit
30951604	Wall and deposit
30951605	Wall and absorption
30951699	*Equipo completo

Applications

Ideal for clearcoats, waterborne products, lacques, fonds, enamels and light primers.

MACK 320

High production

ATEX  II 2 GX

Code	Version
30932001	Trolley and absorption
30932002	Trolley and deposit
30932005	Wall and absorption
30932007	Wall and deposit
30932098	*Full equipment



SAGOLA introduces its new range of professional line RAIDER 300 AIRLESS version.

This line, exclusively designed and manufactured for professional use, gathers high standards both in term of performance and image.

Within the quality standards we focus on simplicity and durability.

Thus, we have redesigned completely the hydraulics. Now it contributes to a long-lasting life even in the worst working conditions and without waiving on its performance.

TECHNICAL DETAILS

- > Pressure ratio 30:1
- > Free flow (60 cycles): 1.8 L/min
- > Product output pressure: max.: 200 bar
- > Air inlet pressure max.: 7 bar
- > Air consumption: 370 L/min
- > Tip max: 0.013"
- > Weight: 15.5 kg



***Full equipment (standard),** includes Raider 300 (Trolley and absorption), PSAM 104, rotating tip, rotating head and 10 m. product hoses (security).

Pneumatic airless pump for high performance.

Ideal for finishes in high production and waterborne products.

Reduced maintenance and self-adjusting packing system.

Clearcoats and waterborne paints, lacquers, basecoats and primers, enamels and antioxidants.

TECHNICAL DETAILS

- > Pressure ratio 32:1
- > Free flow (60 cycles): 2.7 L/min
- > Product output pressure: max.: 226 bar
- > Air inlet pressure max.: 7 bar
- > Air consumption: 610 L/min
- > Tip max: 0.018"
- > Weight: 20 kg



***Full equipment (standard),** includes Mack 320 (Trolley and absorption), PSAM 104, rotating tip, rotating head and 10 m. product hoses (security).

More information and application guides on page 84

INDUSTRIAL PAINTING
Industrial Pumps
Pneumatic
Airless pump

Mack 400 and Mack 600

MACK
400
MACK
600

Prepared for the application of paints with medium - high viscosities

Robust and fast with minimum maintenance

High production Airless pump.

Tungsten Carbide valves.
 Enamels (polyurethanes, epoxy), anti-corrosive primers, intermediate layers and thick, chlorinated rubber, bituminous, mold release,...
 Valid for water-based product applications.

ATEX  II 2 GX

**Full equipment (standard), includes Mack 400/600 (Trolley and absorption), PSAM 107, rotating tip, rotating head and 10 m. product hoses (security).*



Code	Mack 400
30932201	Trolley and absorption
30932299	*Full equipment

Code	Mack 600
30932101	Trolley and absorption
30932199	*Full equipment

TECHNICAL DETAILS

	Mack 400	Mack 600
> Pressure ratio:	40:1	60:1
> Free flow:	7.2 L/min	5.2 L/min
> Max. air consumption:	1,500 L/min	1,500 L/min
> Product output pressure max.:	240 bar	360 bar
> Pressure air inlet máx.:	6 bar	6 bar
> Weight:	62 kg	63 kg
> Supply hose minimum ø:	12.7 mm	12.7 mm
> Recommended maximum nozzle:	0.032"	0.032"
> Maximum nozzle 2 guns:	0.018"	0.018"



TECHNICAL ADVANTAGES / Airless and Mix Equipments

- 1 PNEUMATIC BODY ANODIZED FORGED ALUMINIUM.**
High resistant to corrosion.
- 2 OVERSIZED PNEUMATIC CONTROL AREA.**
To avoid freezing problems and maintain a smooth operation without any loss of performance.
- 3 PNEUMATIC AREA SHAFT GROUND AND CHROMIUM-PLATED.**
- 4 PRODUCT AREA SHAFTS TEMPERED AND CHROMIUM-PLATED.**
Great durability and wearing resistance.
- 5 ALL PACKINGS HAVE BEEN REDESIGNED.**
They offer great durability and smooth-functioning, even working at low pressure.
- 6 NEW OVERSIZED VALVES.**
They provide a better product flow, a lower product flow-speed and therefore, a lower wear.
- 7 COMPACT DESIGN, STURDY and HIGH QUALITY.**
- 8 SIMPLIFIED DESIGN.**
Now there are less parts, so it is easier to maintain and repair.
- 9 ANTI-PULSATION SYSTEM standard for all models.**
- REGULATORS:**
AIRLESS Equipment, Pump pressure regulation system,
MIX Equipment, pump and atomization regulation system.

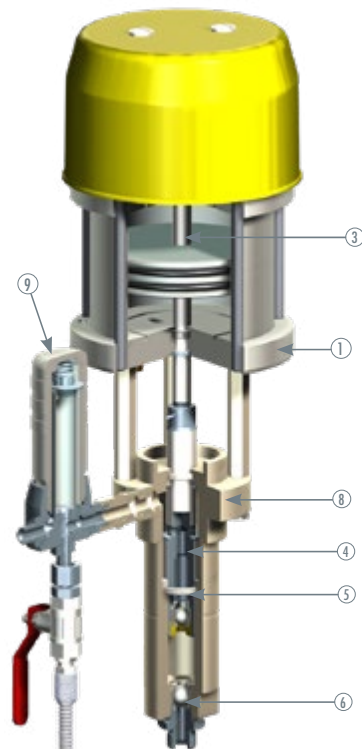

Atlanta 200 Plus and Atlanta 500

ATLANTA
200 PLUS

High-quality paints
 Medium production



Electric membrane pump. Application of clearcoats, undercoats, primers, enamels and varnishes. In general, medium viscosity products.

Code	Atlanta 200 Plus
30941201	Trolley and gravity deposit
30941299	*Full equipment

TECHNICAL DETAILS

- > Single phase motor: 220V - 50 Hz.
- > Power: 1 HP
- > Free flow: 2 L/min.
- > Maximum pressure: 180 bar.
- > Maximum nozzle: 0.018"
- > Weight: 27 kg.



***Full equipment (standard),**
 includes Atlanta 200 Plus, PSAM 104,
 rotating tip, rotating head and 10 m.
 dispersions hoses of product.

ATLANTA
500

High production

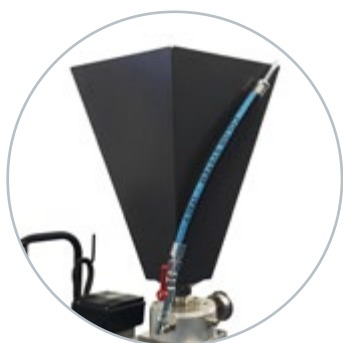

25 L Black deposit Kit

Code

30090075

Airless electric membrane pump for the application of plastic paints, primers, varnishes, chlorinated rubber, waterproof.

Code	Atlanta 500
30940801	Trolley and absorption
30940899	*Full equipment

TECHNICAL DETAILS

- > Single phase motor: 220 V - 50 Hz
- > Power: 2 HP
- > Free flow: 5 L/min
- > Maximum pressure: 220 bar
- > Maximum nozzle: 0.026"
- > Weight: 53 kg



***Full equipment (standard),**
 includes Atlanta 500, PSAM 104,
 rotating tip, rotating head and 10 m.
 dispersions hoses of product.

INDUSTRIAL PAINTING
Industrial Pumps
 Electric
 airless pump

Atlanta 800

ATLANTA
800

Powerful and robust for continuous tasks with 1 or 2 spray guns

Toolbox

Large size rear wheels and front steering for on-site transport

ATLANTA
800G

Petrol

100% Autonomous

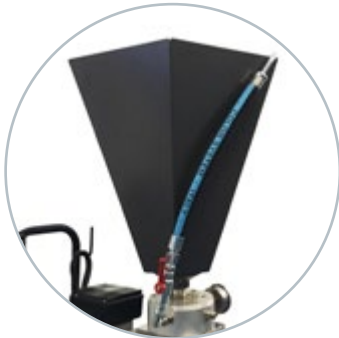

25 L Black deposit Kit

Code

30090075

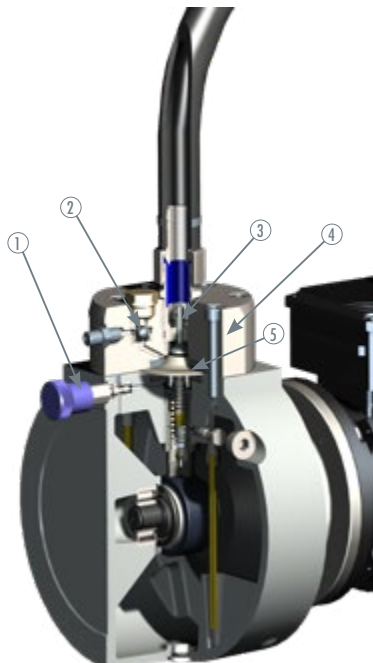

Airless electric diaphragm pump for the application of plastic paints, primers, varnishes, waterproof, fireproof, bituminous, epoxies, chlorinated rubber,....

Includes special anti-vibration system.

Code	Atlanta 800
30940901	Trolley and absorption
30940999	*Full equipment

Code	Atlanta 800 G
30941001	Trolley and absorption



**Equipo completo (estándar), incluye Atlanta 800, PSAM 107, boquilla de giro, cabezal de giro y 10 m. mangueras de dispersiones de producto.*

TECHNICAL DETAILS

	Atlanta 800	Atlanta 800 G
> Maximum pressure:	220 bar	220 bar
> Free flow:	9 L/min	8.5 L/min
> Maximum recommended nozzle:	0.043"	0.036"
With 2 guns aircaps	0.023"	0.023"
> Engine Type:	Single-phase	4 stroke Honda
> Voltage:	230 V / 50 Hz	-
> Power:	2.9 H.P.	5.5 H.P.
> Sound level:	as per CE regulation: 75 DB	-



TECHNICAL ADVANTAGES / Electric Airless Pumps

- 1 PRESSURE REGULATOR**
HIGH PRECISION AND SENSITIVITY.
- 2 COMPLETE ANTI-RETURN VALVE.**
In hard metal.
- 3 VALVE.**
In hard metal.
- 4 PLUGS MADE OF DURALUMINIUM.**
- 5 POLYAMIDE MEMBRANE**
Resistant to wear and solvent.



PSAM 107, PSAM 104 and Pole

**PSAM
107**

For professional use

Extremely robust and durable

Pressure: up to 450 bar

All the advantages of the airless system: speed, high thickness, minimum overspray

Code	Application
30170101	To use with all types of low, medium and high viscosity products.

Does not include swivel head and nozzle

* Recommended airless swivelling HEAD and AIRCAPS (see page 28)

The PSAM 107 is a high pressure airless spray gun. It is a gun for professional use with an anodised aluminium body and comfortable action due to its four-finger trigger.

It is recommended for using with all types of low, medium and high viscosity products.

Both seats and closures are manufactured in tungsten carbide. It incorporates a 1/4-inch revolving coupling and filter holder.

TECHNICAL DETAILS

- > Working pressure: 450 bar
- > Weight: 575 g
- > Screw nozzle: 11/16"



**PSAM
104**

For professional use

Code	Application
30170103	To use with all types of low and medium viscosity products.

Does not include rotating head and nozzle

* Recommended airless swivelling HEAD and AIRCAPS (see page 28)

High pressure spray gun recommended for pneumatic and electric airless systems not exceeding a working pressure of 250 bar. It is recommended for all types of medium viscosity products. Both seats and closures are manufactured in tungsten carbide. It incorporates a 1/4-inch revolving "M" coupling and filter holder.

TECHNICAL DETAILS

- > Max. Working pressure: 260 bar
- > Maximum Working Temperature: 80°C
- > Screw nozzle: 11/16"



Pistola Pole

For professional use

Code	Version
30170105	Pole spray gun
30990381	Pole + roller extension set

Length with roller: 915 mm.



Code
30990368

Airless gun available with die-pressed anodised body. Treated-steel trigger for operation with four fingers and with safety locking system. Both seats and closures are manufactured in tungsten carbide. It incorporates a 1/4-inch revolving "M" coupling. Application of plastic paints with a roller extension.

TECHNICAL DETAILS

- > Max. Working pressure: 220 bar
- > Swivel coupling: 1/4"
- > Weight: 470 g.



INDUSTRIAL PAINTING

Industrial Pumps

Pumps and Airless spray guns accessories

Airless spray guns accessories

Airless Swivel Caps



Application	Name	Nozzle (inch/mm)	Spray angle	Spray width (mm.) at 30 cm.	Air flow at 100 bar (L/min)	Code	Spray gun filter
Finishes	09/20 Swivel Sd V	0.009"/0.23	20°	140	0.25	814 611 05	Red
	09/40 Swivel Sd V	0.009"/0.23	40°	178	0.25	814 611 06	
	11/20 Swivel Sd V	0.011"/0.28	20°	153	0.37	814 611 08	
	11/40 Swivel Sd V	0.011"/0.28	40°	190	0.37	814 611 09	
Basecoats and Primers	13/20 Swivel Sd V	0.013"/0.33	20°	140	0.57	814 611 11	Yellow
	13/40 Swivel Sd V	0.013"/0.33	40°	178	0.57	814 611 12	
	15/20 Swivel Sd V	0.015"/0.38	20°	140	0.72	814 611 15	
	15/40 Swivel Sd V	0.015"/0.38	40°	178	0.72	814 611 16	
	16/40 Swivel Sd V	0.016"/0.41	40°	178	0.80	814 611 20	
	17/40 Swivel Sd V	0.017"/0.43	40°	254	0.98	814 611 24	
	17/60 Swivel Sd V	0.017"/0.43	60°	320	0.98	814 611 25	
High Viscosity	18/40 Swivel Sd V	0.018"/0.46	40°	254	1.10	814 611 28	White
	18/60 Swivel Sd V	0.018"/0.46	60°	330	1.10	814 611 29	
	19/40 Swivel Sd V	0.019"/0.48	40°	254	1.30	814 611 33	
	21/40 Swivel Sd V	0.021"/0.53	40°	279	1.52	814 611 38	
Thick Coats	23/40 Swivel Sd V	0.023"/0.58	40°	280	1.83	814 611 43	White
	25/40 Swivel Sd V	0.025"/0.63	40°	305	2.13	814 611 48	
	25/60 Swivel Sd V	0.025"/0.63	60°	406	2.13	814 611 49	
	31/60 Swivel Sd V	0.031"/0.78	60°	400	3.42	814 611 64	

- The fan size is indicative and it will vary depending on the viscosity and the pressure at which sprayed.
 - Others available nozzle and angles. Consult.

Fixed airless tips



Application	Name	Nozzle (inch/mm)	Spray angle	Spray width (mm.) at 30 cm.	Air flow at 100 bar (L/min)	Code	Spray gun filter
Finishes	09/25 fixed	0.009"/0.23	25°	140	0.25	814 606 41	Red
	09/40 fixed	0.009"/0.23	40°	178	0.25	814 606 42	
	09/65 fixed	0.009"/0.23	65°	235	0.25	814 606 44	
	11/40 fixed	0.011"/0.28	40°	190	0.37	814 606 50	
	11/65 fixed	0.011"/0.28	65°	254	0.37	814 606 53	
Basecoats and Primers	13/25 fixed	0.013"/0.33	25°	140	0.57	814 606 61	Yellow
	13/40 fixed	0.013"/0.33	40°	178	0.57	814 606 62	
	13/65 fixed	0.013"/0.33	65°	254	0.57	814 606 65	
	13/80 fixed	0.013"/0.33	80°	292	0.57	814 606 66	
	15/25 fixed	0.015"/0.38	25°	178	0.98	814 606 72	
	15/40 fixed	0.015"/0.38	40°	216	0.98	814 606 73	
	15/50 fixed	0.015"/0.38	50°	254	0.98	814 606 74	
	15/65 fixed	0.015"/0.38	65°	279	0.98	814 606 75	
	15/80 fixed	0.015"/0.38	80°	330	0.98	814 606 76	
Thick Coats	17/100 fixed	0.017"/0.43	100°	380	1.30	814 606 27	White
	18/40 fixed	0.018"/0.46	40°	254	1.12	814 606 98	
	18/65 fixed	0.018"/0.46	65°	330	1.12	814 607 01	
	21/40 fixed	0.021"/0.53	40°	279	1.52	814 607 14	

- The fan size is indicative and it will vary depending on the viscosity and the pressure at which sprayed.
 - Others available nozzle and angles. Consult.

Airless tips adjustable fan pattern



Code	Name
814 609 77	15 reg. spray pattern airless tips
814 609 78	20 reg. spray pattern airless tips

Swivel head



Code	Usage
814 611 01	PSAM 107/104. for setting up the airless swivel caps

Airless pumps accessories

Angular head

Code	Usage
309 903 71	PSAM 107/104



Extensions

Code	Name
300 103 02	300 mm. airless extension
300 103 03	500 mm. airless extension
300 103 04	1,000 mm. airless extension
300 103 01	150 mm. 45° airless extension

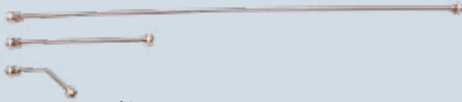

Pole accessories

Code	Name
309 903 70	Spare parts for roller
309 903 69	Roller for extension
309 903 68	915 mm. extension kit with roller



Cleaning

Code	Name
300 102 07	Cleanliness needles (12 pcs.)



Spray gun filters

Referencia	Denominación
300 100 08	1 - White airless 10 filters Kit
300 100 09	2 - Yellow airless 10 filters Kit
300 100 10	3 - Red airless 10 filters Kit
864 630 04	4 - Filter kit 100 sheets

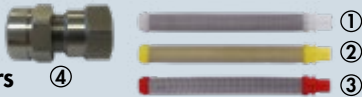

Filter Accessories Pump Anti-recoil

Code	Name
836 600 09	100-mesh mix/airless filter
836 600 10	60-mesh mix/airless filter



Absorption Filters

Code	Name
564 180 55	40 microns circular filter + spring
836 600 47	Special absorption filter for narrow pass
300 900 34	Absorption head for electric airless
536 105 10	Black deposit filter kit for electric airless

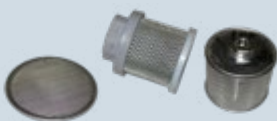

Code	Name
OIL	
300 900 99	Hydraulic Oil RENOLIN MR10 (Electric Airless)
300 900 98	Packing oil OILPACK (Pneumatic airless/mix)
ELECTRIC MEMBRANE UNITS	
300 900 21	Atlanta 200 Plus/500/800 Antireturn valve
875 600 01	Atlanta 200 absorption valve
875 600 03	Atlanta 200 Plus/500/800 absorption valve
300 900 23	Atlanta 200 PLUS membrane kit (includes seat and oil)
300 900 22	Atlanta 500/800 membrane kit (includes seat and oil)
864 647 01	Atlanta 200 Plus pressure regulator
864 647 03	Atlanta 500/800 pressure regulator
300 900 87	Atlanta 500 drain set
864 652 04	Atlanta 500/800 full absorption sensor
PISTON PNEUMATIC	
842 600 99	Complete drain set
864 652 06	Complete absorption set
300 900 91	Complete deposit set
564 185 42	Mack 150/320 absorption valve set
564 185 45	Mack 150/320 Lower packing set
564 185 46	Mack 150/320 Upper packing set
564 185 44	Mack 150/320 Complete hydraulic axis kit
564 184 89	Raider 160/260 Pneumatic axis kit
564 185 39	Mack 320 Pneumatic axis kit



Airless product hose

Code	Name
86463802	10 m. C/T Dispersal hose, electric machines
86463803	20 m. C/T Dispersal hose 1/4, electric machines
86463821	5 m. C/Therm. 3/16 hose
86463826	5 m. C/Therm. 1/4 hose
86463827	10 m. C/Therm. 1/4 hose
86463828	15 m. C/Therm. 1/4 hose
86463834	10 m. C/T safety 1/4 hose



Filters and Sundry Accessories

Code	Name
836 600 55	High capacity filter set (1L.)
836 600 58	200-mesh filter
836 600 56	300-mesh filter
836 600 57	In line filter with swivel coupling, 100 mesh
857 603 01	Airless hose couplings 1/4" - 1/4"

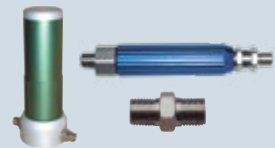

INDUSTRIAL PAINTING
Industrial Pumps
Industrial turbines

Turbo 3000 Pro and Turbo 2200 Pro

TURBO3000
PRO

- High performance
- Maximum quality
- Very wide fan patterns
- Nozzle and needle in stainless steel
- 3-stage turbine



Professional HVLP autonomous tool. High performance.

Minimum mist.

Autonomous Turbine Equipment for the application of dyes, lacquers, enamels, clearcoats, primers, textured products and cast iron effect.

Ideal for painting and assemblies works.

Metallic spray gun with fan and product regulators. Deposit with anti-return valve, flange closure and anti-drip lid.

Includes double removable air filter.



TECHNICAL DETAILS

- > Electric motor: Direct Current
- > Power: 1,400 w
- > Motor consumption: 6.1 Amp.
- > Free flow: 2,500 L/min
- > Maximum working pressure: 0.3 bar
- > Hose length: 8 m.
- > Weight: 12 kg
- > Transfer: 75%



Code	Version
56418597	Turbine air filters kit (6 units)

Code	Version
30640201	Complet equipment Trubo 3000 Pro

Combinations SAGOLA 455 Spray Gun



Code	Version	Application
10110501	1.40 [80]	Finishes, basecoats and primers
10110502	1.00 [80]	High gloss finishes and dyes
10110503	1.20 [80]	General finishes
10110505	1.80 [80]	Viscous products, primers, acrylics
10110506	2.20 [80]	Textured products, cast iron effect

Air regulator in turbine hose



TURBO
2200PRO

- Very wide fan patterns
- Stainless steel nozzle and needle
- 3-stage turbine

Autonomous Turbine Equipment for all type of industry, with a power of 1,300 w.

Excellent atomization. Ideal for painting and assemblies works.

Metallic spray gun with fan and product regulator. Deposit with anti-return valve, flange closure and anti-drip lid.

Hose length 6 meter
 Removable double air filter.



TECHNICAL DETAILS

- > Electric motor: 220 V - 50 Hz
- > Power: 1,300 w
- > Free flow: 2,000 L/min.
- > Maximum working pressure: 0.3 bar
- > Weight: 10 kg
- > Transfer: 75%



Code	Version
30640401	Full Equipment 220 V / 50 Hz

Code	Version
56418663	Consumible: Kit filtros turbina 6 uds

Industrial pressure pots

SAGOLA pressure pots come into their own when pumping equipment demands the maximum durability and minimum maintenance, even with the most abrasive paints (ceramic and vitro-ceramic clears, cast iron effect, pastes...) or corrosive products (dyes, waterborne paints, waterborne adhesives...).

- > Manufactured in stainless steel.
- > Produced according to the most demanding international standards.
- > Extreme manufacturing quality and precision.
 - > Maximum safety.



INDUSTRIAL PAINTING

Industrial pressure pots
Upper outlet pots

6110 Inox and 6110 Inox Co

6110 INOX

Made of stainless steel
10 L. capacity

Double, high precision, robust regulator with anti-return valve

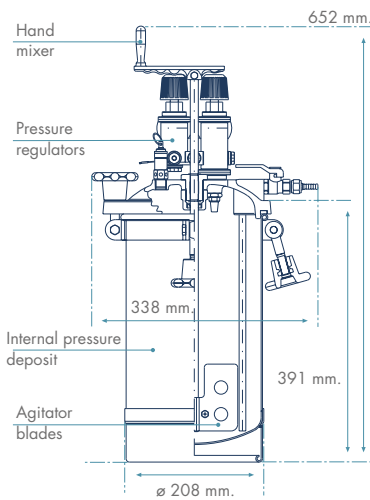

Code	Version
52411607	10 L. stainless steel interchangeable tank

Offers the maximum durability due to the stainless steel body and lid.

Double, high precision, robust regulators with anti-return valve.

Valid for waterborne and solvent-based paints.

6110 homologation:

- > SPAIN: AP 1070 FBZ 2330
- > FRANCE: CODAP
- > GREAT BRITAIN: British Standard 1101-1977
- > GERMANY: A.D. Merkblätter
- > ATEX 2 II GX

TECHNICAL DETAILS

- > Hand mixer
- > Optional interchangeable stainless steel deposit
- > Maximum inlet pressure: 4 bar
- > Air inlet: 1/4" BSP
- > Product outlet: 3/8" BSP
- > Product pressure gauge: 0 - 4 bar
- > Air pressure gauge: 0 - 8 bar



Code	Version
10540702	6110 Inox pressure pot
10540799	*Full equipment



The full equipment includes: 6110 INOX pressure pot, air + product hose (5 m.) and 4100 Xtreme spray gun.

6110 INOX Co

Special for adhesives

Recommended for SAGOLA adhesive guns

10 L capacity

Code
10550202

The 6110 has a special version for bead application of adhesives which differs from its predecessor in the greater pressure it can handle (up to 7 bar), in addition to the absence of the agitator and the single regulator.

6110 homologation:

- > SPAIN: AP 1070 FBZ 2330
- > FRANCE: CODAP
- > GREAT BRITAIN: British Standard 1101-1977
- > GERMANY: A.D. Merkblätter
- > ATEX 2 II GX

Certificate N°: FBC - 9168

TECHNICAL DETAILS

- > Maximum working pressure: 7 bar
- > Air inlet: 1/4" BSP
- > Product outlet: 3/8" BSP
- > Product pressure gauge: 0 - 8 bar



610, 612 pressure pots and hoses

610
 Pressure pot

Code	Version
40000273	610 pressure pot
10540798	*Full equipment

***Full equipment:** includes 610 pressure pot, air and product hoses (5 m.) and 3300 GTO pressure 1.40 EPA.

Steel body and aluminium lid.
 Top outlet. Valid for solvent-based paints.
 Low and medium viscosity paints.
 > ATEX  2 II GX

TECHNICAL DETAILS

- > 10 liters capacity
- > Steel body and aluminium lid
- > Without product agitator
- > Double regulation
- > Valid for solvent-based paints
- > Working pressure: max. 4 bar
- > Product outlet: 3/8"
- > Air inlet: 1/4"



612

Easy to use
 Robust

Minimum maintenance

Ideal for Industrial bodyshop

Code	Version
10540801	612 pressure pot
10540899	*Full equipment

Air + product hose
 Kit. 1.8 m.

Code
56414128

Pressure pot. Aluminum body and lid. 2.5 litres deposit capacity. Top outlet and pressure regulator.
 Valid for waterborne and solvent-based paints.
 > ATEX  2 II GX

TECHNICAL DETAILS

- > Pressure ratio 1 : 1
- > Deposit capacity: 2.5 L
- > Working pressure: max.: 3.3 bar
- > Air inlet: 1/4"
- > Product outlet: 3/8"



***The full equipment** includes: 612 pressure pot, 4100 Xtreme Pressure 1.20 (XT01 B) and 1.8 m. air and product hoses.

Air hoses for PRESSURE POTS



Air hoses. Anti-static

Code	Name
56414014	2.5 m. 6x12mm F/F 1/4"
56414024	6 m. 8x15mm F/F 1/4"
56414025	11 m. 8x15mm F/F 1/4"
56414027	16 m. 8x15mm F/F 1/4"
56414026	26 m. 8x15mm F/F 1/4"

Product hose. Anti-static

Anti-static aerographic hose for Waterborne/Solvent.
 8x16 mm. F/F 3/8"

Code	Name
56414116	6 m. 8x16mm. F/F 3/8"
56414117	11 m. 8x16mm. F/F 3/8"
56414115	16 m. 8x16mm. F/F 3/8"

Air + Product hose. Aerographics

Code	Name
86463818	5 m. spray gun hose set. (6 mm+8 mm) HVLP
86463819	10 m. spray gun hose set. (6 mm+8 mm)
86463891	Adhesives 10 m. air hose 8 mm. + 10 mm. Product hose
86463894	Dyes 5 m. air hose 8 mm. + 3 mm. Product hose

Air + Product hose + cover. Aerographics. Lights

Code	Name
56414039	5 m. Air hose 8x15 mm. + product hose 6x8 mm. set + cover
56414040	10 m. Air hose 8x15 mm. + product hose 6x8 mm. + cover
56414041	15 m. Air hose 8x15 mm. + product hose 6x8 mm. + cover
56414042	20 m. Air hose 8x15 mm. + product hose 6x8 mm. + cover

High Viscosity product hose. Aerographics

Code	Name
56414111	Product Hose 5m. 20x26mm. F/F 3/4". Waterborne
56414112	Product Hose 10m. 20x26mm. F/F 3/4". Waterborne
56414113	Product Hose 15m. 20x26mm. F/F 3/4". Waterborne
56414101	Product Hose 5m. 25x33mm. Kamlock Kit. Waterborne
56414129	Product Hose 10m. 12x21mm. F/F 3/4". Solvent

INDUSTRIAL PAINTING

Industrial pressure pots

Upper outlet pots

652 Inox and 653 Inox

652 Inox

25 L. stainless steel pot

Optional interchangeable deposit

Code	Version	Model
10540320	652 Inox MDS	Manual agitator, double regulation, without wheels
10540321	652 Inox RDC	Pneumatic rotary agitator, double regulation, with wheels.
10540322	652 Inox ADC	Pneumatic alternative agitator, double regulation, with wheels.



TECHNICAL DETAILS

- > 25 liters capacity
- > Top outlet
- > With manual agitator
- > Maximum working pressure: 4 bar.



ATEX Ex 2 II GX
Certificate N° AP - 1035

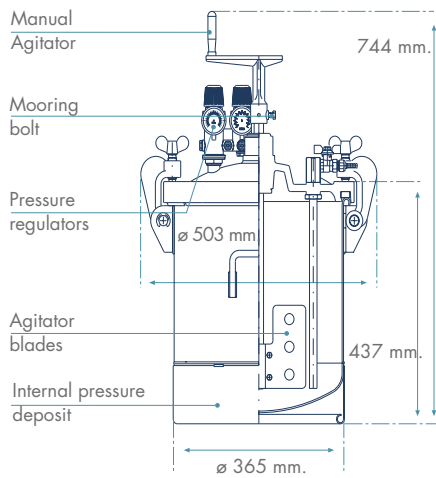

Code	Version
52411608	25 L. stainless steel interchangeable tank

653 Inox

50 L. stainless steel pot

Optional interchangeable deposit

Code	Version	Model
10540420	653 Inox MDS	Manual agitator, double regulation, without wheels
10540421	653 Inox RDC	Pneumatic rotary agitator, double regulation, with wheels.
10540422	653 Inox ADC	Pneumatic alternative agitator, double regulation, with wheels.



TECHNICAL DETAILS

- > 50 liters capacity
- > Top outlet
- > With manual agitator
- > Maximum working pressure: 4 bar



ATEX Ex 2 II GX
Certificate N° AP - 1035

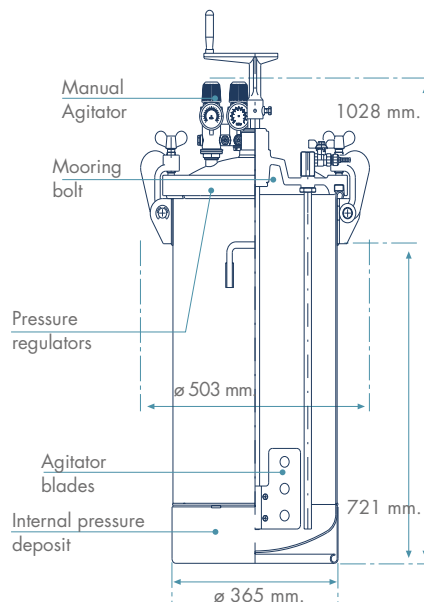

Code	Version
52411609	50 L. stainless steel interchangeable tank

Premium 30, Premium 60 and Classic 30 Inox



Smooth paints, Adhesives
 High viscosity



Stone paste, rough products and Slurry

Premium 30

With double handlebar,
 foldable for transport

Two handles for holding

Code

20530520



30 L. pressure pot (two 25 Kg. bags of paste).
 Two lower product outlets:

- a) for dense products (20 mm interior Ø. hose and 3/4" thread).
- b) for regular products (8 mm interior Ø. hose and 3/8" thread).

Application of gotelé, plastic paints, thick products and paints in general of medium and low viscosity.



TECHNICAL DETAILS

- > Maximum working pressure: 7 bar
- > Homologation n° FBZ-2330
- > ATEX 2 II GX



Premium 60

With double handlebar,
 foldable for transport

Two handles for holding

Code

20530620

60 L. pressure pot (two 25 Kg. bags of paste).
 Two lower product outlets:

- a) for dense products (20 mm interior Ø. hose and 3/4" thread).
- b) for regular products (8 mm interior Ø. hose and 3/8" thread).



TECHNICAL DETAILS

- > Maximum working pressure: 7 bar
- > Homologation n° FBZ-2330
- > ATEX 2 II GX



Classic 30 Inox

With handlebar,
 foldable for transport

Code

20530702

30 L. pressure pressure pot. (two bags of 25 kg. of paste).

TECHNICAL DETAILS

- > Maximum working pressure: 7 bar
- > Bottom-mounted product outlet 3/4"
- > Empty weight: 31 kg.
- > ATEX 2 II GX



INDUSTRIAL PAINTING
 Industrial pressure pots
 Pneumatic
 Mixers

463/ 471 and 446/ 464



463



471

463/ 471

Pneumatic motor and alternative agitator.

Code	Version
10510201	Pneumatic motor 463
10520201	Alternative agitator 471

TECHNICAL DETAILS

- > Fits pots 652 and 653
- > Air consumption: 28 L/min (1 CFM)
- > Speed regulator: 10 - 20 oscillations/min
- > Working pressure: 1 to 6 bar (14.5 to 87 psi)
- > Makes alternative oscillating movements through 180°
- > Air inlet: BSP 1/4"
- > ATEX  2 II GX



446



464

446/ 464

Pneumatic motor and rotary agitator.

Code	Version
10510101	Pneumatic motor 446
10520101	Rotary agitator 464

TECHNICAL DETAILS

- > Fits pots 652 and 653
- > Air consumption: 392 L/min (14 CFM)
- > Speed regulator up to 300 r.p.m.
- > Power: 0.5 HP
- > Working pressure: 1 to 6 bar (14.5 to 87 psi)
- > Air inlet: BSP 1/4"
- > ATEX  2 II GX





DM400, DM300 & TB270 Inox

DM 400

Double membrane fluid supply pump.

Clearcoats, paints solvents, dyes, lubricants, glues and adhesives, oils and dirty oils. In general, low and medium viscosity products.

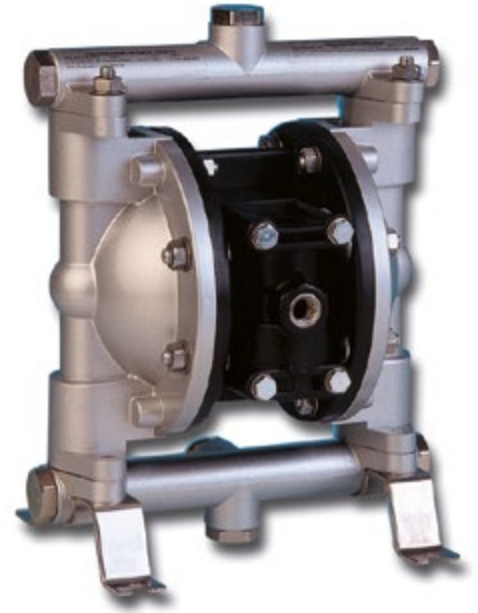

Code	DM400 version
30910101	Standard
30910102	Abrasive Products

TECHNICAL DETAILS

- > Pressure ratio 1:1
- > Maximum flow 40 L/min
- > Maximum pressure: 7 bar
- > Air consumption: 580 L/min
- > Weight: 6 kg
- > Air inlet: BSP 1/4"
- > Product Inlet and outlet: 1/2"
- > ATEX 2 II GX



DM 300

Double membrane fluid supply pump.

Clearcoats, glues and adhesives, laquers, paints solvents, dyes, oils and dirty oils. Generally, low and medium viscosity products.



Code	DM300 version
30910105	Standard

TECHNICAL DETAILS

- > Pressure ratio 1:1
- > Maximum flow 30 L/min
- > Maximum pressure: 7 bar
- > Air consumption: 380 L/min
- > Weight: 4.5 kg
- > Air inlet: BSP 1/4"
- > Product Inlet and outlet: BSP 3/8"



TB270 Inox

Fluid supply piston pumps.

Clearcoats, paints solvents, dyes, lubricants, glues and adhesives. Stainless steel versions for corrosive and waterborne products.



Special for recipients.

Code	Version
30910501	TB 270 Long Aluminium
30910502	TB 270 Short Aluminium
30910503	TB 270 Long Stainless Steel
30910504	TB 270 Short Stainless Steel

TECHNICAL DETAILS

- > Pressure ratio 1:1
- > Maximum flow 60 L/min
- > Maximum pressure: 7 bar
- > Air consumption: 230 L/min
- > Weight: 7 kg
- > Air inlet: BSP 1/4"
- > Product outlet: BSP 3/4"
- > Recipient thread: BSP 2"
- > ATEX 2 II GX



INDUSTRIAL PAINTING
 Industrial pressure pots
 Pumps and
 fluid supply syst.

Recipient Lid



ATEX  2 II GX

Recipient lid kit

Stainless steel

Code	Version
30990354	For 200 L. recipient

**Recipient lid kit
 + rotary agitator**

Code	Version
30990359	For 200 L. recipient

**Recipient lid kit
 + DM pump + Air
 inlet regulator**

Code	Version
30990358	For 200 L. recipient

**Recipient lid kit +
 DM pump + rotary
 agitator + Air inlet
 regulator**

Code	Version
30990356	For 200 L. recipient

**Recipient lid kit
 + TB 270 pump + Air
 inlet regulator**

Code	Version
30990357	For 200 L. recipient

**Recipient lid kit
 + TB 270 pump + rotary
 agitator + Air inlet
 regulator**

Code	Version
30990355	For 200 L. recipient



Aerographic spray guns

SAGOLA aims to provide **the best response to industrial painting needs** with this range of spray guns.

- > Maximum productivity
- > Improved productivity of the painting line
- > Time and product savings
- > Minimization of mist and solvent emissions
- > Cost reductions related to equipment maintenance
- > Achieving the maximum finishing quality standards

SAGOLA offers all its experience in finishing to supply industrial painting sectors with **highly competitive tools and equipment** for the following sectors:

- > **Wood, metal, plastic, industrial vehicle and automotive production lines, industrial machinery, maritime, ceramics, tannery finishes...**

Our daily commitment: to respond to the new challenges in paints and coatings for industrial surfaces.

- > Finishes with the maximum gloss requirements
- > High-solid paints and clearcoats and waterborne finishes
- > Dyes and metallized products
- > Paints, ceramics and abrasive and corrosive products

With the aim of meeting these objectives we offer **high transfer spray guns** which meet the most demanding solvent emission regulations and standards:

- > **HVLP and EPA, Mix, Airless** spray guns...

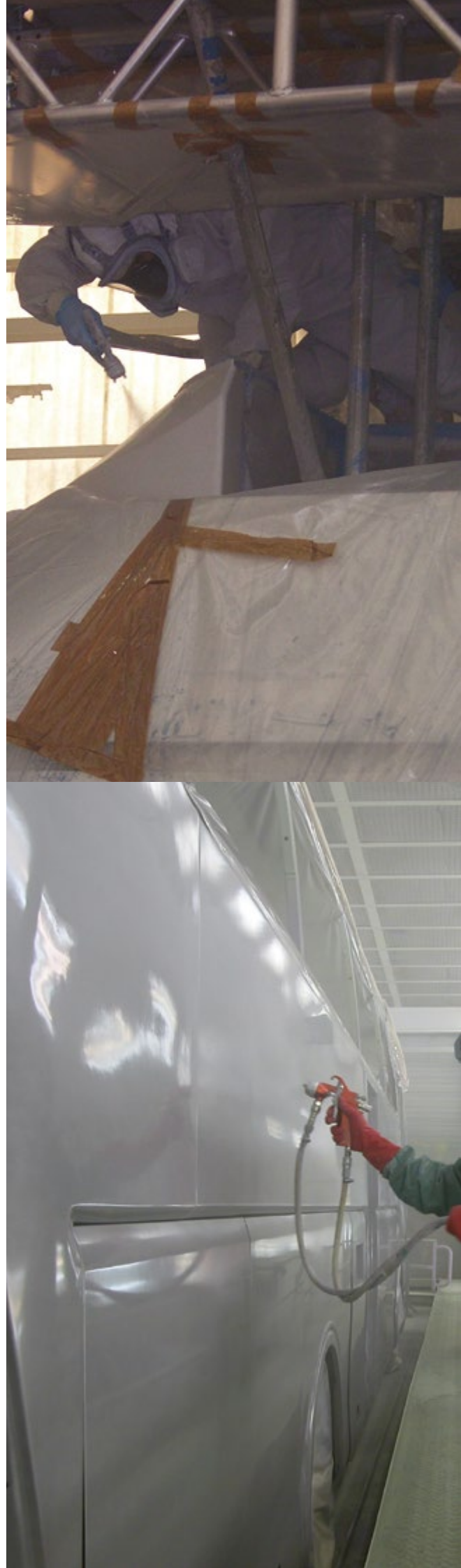

INDUSTRIAL PAINTING
Aerographic spray guns
 Suction
 spray guns

4100 Xtreme Suction

4100
XTREME



New appearance. High resistance polishing and anodizing

Ideal for painting large areas, machinery and industrial vehicles

Extra deposit capacity and application speed

Ideal for continuous work sessions and large surfaces. More comfortable painting and less tiredness due to the low gravity center



Aluminium high capacity deposit (1L)

Double watertight gasket system
 Clamp gasket and anti-drip lid

Maximum use of paint level



Forged aluminium body

High quality chromed finish

Nozzle and needle on a single stainless steel part

Suction system of our 4100 allows painting at right angles with the piece when painting bonnets, roofs, vehicles' inside parts, trucks' chassis, trailers, etc.

TECHNICAL DETAILS

- > Weight with deposit: 880 g
- > Dimensions: 30 cm x 18 cm x 11 cm
- > Air inlet couplings BSP 1/4" male
- > Design pressure: 8 bar
- > Maximum recommended inlet pressure (working pressure): 2 - 2.5 bar
- > Maximum recommended application distance: 18 - 22 cm
- > Air consumption:
 Aircap 96: 298 L/min
 Aircap XT01B: 300 L/min
- > Materials in contact with the product:
 INOX, chromed aluminium, POM, Teflon, Nylon.
- > ATEX II 2G T60°C X

Code	Version	Application
10120601	1.40 [96]	General finish
10120602	1.60 [96]	General finish
10120603	1.80 [96]	High speed Finishes, Primers
10120604	1.60 [XT01B]	Top quality finishes
10120605	1.80 [XT01B]	High speed, large surfaces

Medium pressure
 55% Transfer

96
 Maximum spraying quality

EPA System
 65% Transfer
XT01B EPA
 High performance
 High quality



3300 GTO

3300 GTO Suction

Lighter and robust

New body, maximum ergonomics

Time saving

Top-range and Low consumption High-end Aluminium aircaps

There are no gaskets in couplings between air and paint

Versatile

Extra deposit capacity (1L.)



Application of enamels, varnishes, primers and basecoats.

Nozzles and needles in stainless steel.

HVLP and EPA aircaps that comply with regulations concerning solvent emissions.

Aircap EPA: Minimum air consumption with high quality application (>2HP).

REGULATIONS / PATENTS / REGISTRATIONS

SAGOLA registers the shapes of its guns and its brand/trademark worldwide, and complies with the strictest safety standards and with the strictest standards on solvent emissions:

- > CE
- > EN 1953
- > ATEX  II 2G T60°C X
- > Design in EU: D-C 924667-0004
- > Design in Asia: 200830139660.3

With a light injected-aluminium body, it is a top level product with an excellent price/quality ratio.

High performance. High speed application. Large size fan.

TECHNICAL DETAILS

- > Weight: 925 g
- > Dimensions: 29 x 17.5 x 11 cm
- > Product inlet: 3/8" M BSP
- > Air inlet: 1/4" M BSP
- > Design pressure: 8 bar
- > Maximum recommended inlet pressure (working pressure): 2 bar
- > Maximum recommended application distance:
3300 EPA: 15 - 18 cm
- > Air consumption (2 bar inlet):
3300 EPA: 240 L/min
- > Average sound pressure level: 80 dB
- > Materials in contact with product:
chromed aluminium, anodized aluminium, POM, INOX, Teflon.

Code	Version	Application
10120910	1.40 [EPA]	High quality finishes. Dyes, metallics
10120911	1.60 [EPA]	General finishes
10120912	1.80 [EPA]	Primers and finishes

EPA System
65% Transfer
EPA
Minimum air consumption



INDUSTRIAL PAINTING
Aerographic spray guns
 Suction
 spray guns

Classic Pro Suction and 3300 New Press

Classic Pro Suction

Maximum ergonomics

Maximum robustness
 and reliability

Low air consumption

Smooth trigger action

High spray quality

The best price-quality ratio in conventional spray guns.

Aluminium regulators.

Single spindle design means fewer parts.
 One-piece packing nut. There are no O-rings.

Stainless steel nozzle and needle.



TECHNICAL DETAILS

- > Weight with deposit: 928 g
- > Dimensions: 29 x 17.5 x 11 cm
- > Air inlet coupling thread BSP 1/4" male
- > Maximum air pressure: 8 bar
- > Maximum recommended inlet pressure (working pressure): 2.5 - 3.0
- > Maximum recommended application distance: 20 - 25 cm.
- > Air consumption: 21 Aircap : 210 L/min
- > ATEX **Ex** 2 II GX



Code	Version
10120701	1.60 [21] General finishes
10120702	1.80 [21] Primers, basecoats

3300 New Press

Teflon-coated body
 makes cleaning easy

ATEX **Ex** 2 II GX

Spray gun with pressurised deposit, ideal for the application of medium and high viscosity products.

Multiple regulators (fan pattern, flow, product).

Combinations:

- > **2.0 (27)**: application of multi-colour paints for the construction industry. Very low air consumption.
- > **2.0 (64)**: application of textured effects for industry



Code	Version
10151511	Press pressure 2.00 [27]
10151512	Press pressure 2.00 [64]



INDUSTRIAL PAINTING

Aerographic spray guns

Gravity spray guns

4100 Xtreme Gravity



Trigger and axle made in stainless steel. Ultra-ergonomic design.

Nozzle and Needle in INOX.

All records in contact in the body made of Stainless steel.



One piece product packing nut. Made in Stainless Steel.

Exclusive on the market.

With no joints to manipulate when disassembling for through cleaning of the paint part.



Forged anodized aluminium body

Robustness and high protection against corrosion.

More rounded, ergonomic and comfortable grip.

A perfect balance in the movements.

New modern design of regulators.

Without edges. Easy to clean.

New design of the range of Sagola 4100 gravity version. Maximum robustness and reliability.

Ideal for painting large areas with extreme finishing in sectors such as automotive, industrial vehicles and all types of industrial machinery.

Nuevo body design, lightweight and ergonomic. Anodized forged aluminium body. Maximum durability and minimum maintenance.

There are no gaskets in couplings between air and paint.

Machining of high technology.



TECHNICAL DETAILS

- > Weight without deposit: 515 g
- > Dimensions: 20 x 18 x 4,2 cm
- > Air inlet coupling thread BSP 1/4" male
- > Deposit capacity: 650 ml
- > Deposit with removable anti-drip system
- > Incorporates 100-mesh paint filter
- > Maximum air pressure: 8 bar
- > Maximum recommended inlet pressure (working pressure): 2 bar.
- > Maximum recommended application distance:
 - 62S/64S/96+: 20 - 25 cm
 - XT01: 18 - 20 cm
 - XT03 HVLP: 12 - 15 cm
- > Air consumption:
 - 62S: 310 L/min
 - 64S: 300 L/min
 - 96+: 250 L/min
 - XT01: 245 L/min
 - XT03 HVLP: 500 L/min
- > Materials in contact with the product: INOX, anodized aluminium, POM, Teflon and Nylon.
- > ATEX (Ex) II 2G T60°C X

Medium Pressure System
55% Transfer
96
High quality
64 S
Max. atomization



EPA System
65% Transfer
XT01 EPA
High performance
High quality



HVLP System
72% Transfer
XT03 - HVLP
Minimum mist



Code	Version	Application
10142012	1.30 [96]	Fluid finishes, metallics, dyes
10142001	1.40 [96]	High quality finishes
10142002	1.60 [96]	General finishes
10142003	1.80 [96]	Primers and basecoats
10142016	2.20 [64S]	High viscosity products
10142004	1.30 [XT01]	Dyes
10142005	1.40 [XT01]	General finishes
10142006	1.60 [XT01]	High speed finishes
10142007	1.30 [XT03]	Dyes
10142008	1.40 [XT03]	General finishes
10142009	1.60 [XT03]	High speed finishes
10142010	1.80 [XT03]	Primers and basecoats

*ASK FOR T.C. special nozzles.

INDUSTRIAL PAINTING

Aerographic spray guns

Gravity spray guns

Mini Xtreme Gravity

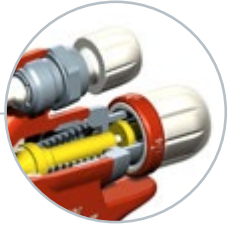

High precision aluminium **product and fan pattern regulators** designed for easy handling even when wearing gloves.

Numbered product regulator for totally accurate paint control.



There are no gaskets in couplings between air and paint.

Designed without O-rings in the air system.

Couplings in stainless steel.



SSAGOLA Xtreme system in compact size.

Thoughtful grip design.



Code

55711622

Connection coupling

M12 male - 1/4" female

Mini Xtreme

Small and light, with perfect ergonomics

Perfect for retouching in vehicle production lines

Ideal for parts coating: wood, plastic and tannery products

Highest quality finishes

Solid: manufactured in forged aluminium

Perfect for dyes and metallized products

500 c.c. deposit

"Control" is the word that best defines the new SAGOLA Mini Xtreme.

It ensures the perfect air-paint ratio for every situation. Work with the correct fan pattern sizes without running the risk of overloading and wrong paint particle sizes. It reduces mist, saves paint and perfectly defines the work zone.

Fan patterns designed to obtain the best drying times with the finest finish, always with minimum pressures.

Specific high-transfer aircaps with an exclusive air diffusion system to achieve a smooth spraying with low pressure.



TECHNICAL DETAILS

- > Weight with deposit: 505 g
- > Dimensions: 29 x 16 x 11 cm
- > Air inlet coupling thread 1/4" male
- > Deposit capacity: 500 ml
- > Deposit with removable anti-drip system
- > Incorporates 100-mesh paint filter
- > Maximum air pressure: 8 bar
- > Maximum recommended inlet pressure (working pressure): 2.0 bar.
- > Maximum recommended application distance:
 - Mini EPA: 15 - 18 cm
 - Mini HVLP: 10 - 15 cm
 - Mini TECH: 15 - 18 cm
- > Maximum Air consumption:
 - Mini EPA: 190 L/min
 - Mini HVLP: 325 L/min
 - Mini TECH: 52 L/min
- > Materials in contact with the product: INOX, anodised aluminium, POM, Teflon, Nylon.
- > ATEX 2 II GX



Code	Version	Application
10111806	0.80 [miniEPA]	Fine feathering, basecoats
10111807	1.00 [miniEPA]	Retouching. feathering. Waterborne and solvent-based basecoats. Clearcoats and dyes
10111808	1.20 [miniEPA]	Clearcoats, UV paints Extremely high finish quality.
10111804	1.30 [miniHVLP]	Especially for dyes: wood, tannery products, footwear.
10111805	1.40 [miniHVLP]	Finishes, dyes
10111811	0.60 [miniTECH]	Primers for leather with low viscosity products.
10111812	1.00 [miniTECH]	Lettering and small retouches.

EPA System
65% Transfer

Mini EPA



HVLP System
75% Transfer

Mini HVLP



Round Jet System

Round Jet





INDUSTRIAL PAINTING

Aerographic spray guns

Gravity spray guns

3300 GTO Gravity



3300 GTO

Light weight

New body, maximum ergonomics

Time saving

Top quality aluminium aircaps

There are no O-rings

New 3300 GTO model. SAGOLA sets the pace in the mid to high range of spray guns for finishes. Forged and anodized aluminum body. This is a top level product with a magnificent price-quality ratio.

EVO aircap: High quality finishes with high-speed industrial application.

EPA aircap: minimum air consumption with high quality application (>2HP).

HVLP aircap: maximum paint savings and minimum mist.



Ergonomic trigger

Made of Stainless Steel.
Reduces fatigue.



New Product regulator

Air Flow, paint flow and fan control redesigned.

Improved balance

Perfect distribution of material, reinforcing critical areas.



Automatic packing gland

Perfect adjustment to the needle. Less risk of damaging the needle. Less contamination of paint.



TECHNICAL DETAILS

- > Weight with deposit: 423 g
- > Dimensions including deposit: 34.5 x 10 x 18cm
- > 1/4" BSP air inlet coupling
- > Deposit capacity: 650 ml
- > Deposit with removable anti-drip system
- > Design pressure: 8 bar
- > Maximum recommended inlet pressure (working pressure): 2 bar
- > Recommended application distance:
 - GTO TECH: 18 - 20 cm
 - GTO HVLP: 12 - 15 cm
 - GTO EPA / GTO EVO: max. 18 cm
- > Fan size:
 - GTO TECH / GTO HVLP: 290 - 300 mm
 - GTO EPA: 250 mm
 - GTO EVO: 280 mm
- > Air consumption per aircap (2 bar inlet):
 - GTO TECH: 290 L/min / GTO HVLP: 360 L/min
 - GTO EPA: 240 L/min / GTO EVO: 320 L/min
- > Average sound pressure level: 80 dB
- > Materials in contact with product: anodized aluminium, chromed aluminium, POM, INOX, Teflon.



REGULATIONS / PATENTS / REGISTRATIONS

SAGOLA registers the shapes of its guns and its brand/trademark worldwide, and complies with the strictest safety standards and with the strictest standards on solvent emissions:

- > CE
- > EN 1953
- > ATEX II 2G T60°C X
- > SQMDA 1151
- > SQMDA 1136

	Code	Case code	Version	Application
EVO System 65% Transfer	10141559	-	1.3 [EVO]	Dyes
EVO Max. speed	10141560	-	1.4 [EVO]	High gloss finishes. Lacquers
	10141561	-	1.6 [EVO]	High speed finishes
HVLP System 72% Transfer	10141555	-	1.40 [HVLP]	Finishes, dyes
HVLP Minimum mist	10141556	-	1.60 [HVLP]	General finishes
	10141557	-	1.80 [HVLP]	Primers and basecoats
EPA System 65% Transfer	10141562	10141578	1.40 [EPA]	Finishes, dyes
EPA High performance	10141563	10141579	1.60 [EPA]	General finishes
Medium Pressure System 55% Transfer	10141564	10141580	1.80 [EPA]	Primers
	10141572	-	2.20 [64S]	Primers. Waterborne clearcoats
64S - 62S Max. spraying	10141574	-	2.80 [62S]	Gun-applied mastics. Polyester, cast iron effect

INDUSTRIAL PAINTING

Aerographic spray guns

Gravity spray guns

Classic Pro XD

Maximum ergonomics and comfort

New body design

No joints between air and paint

Internal air distributor

Nozzles and needles in Stainless steel

Chromed Matt

Code	Version
10141620	1.40 [21EPA] Finishes
10141623	1.60 [21EPA] Finishes and Primers
10141625	1.80 [21EPA] Primers and basecoats
10141627	2.00 [25] Thick primers
10141629	2.50 [36] High Viscous
10141630	2.80 [28] Gun applied mastics
10141621	1.40 [HVLV] Finishes
10141624	1.60 [HVLV] Finishes and Primers
10141626	1.80 [HVLV] High thickness
10141631	2.50 [HVLV] High Viscous

475 XTECH

Precision solutions for those small details and retouches

Highest spray quality

Very light injected aluminium body

ATEX  2 II GX

Code	Version
20140801	0.50 [05]
20140802	0.80 [05]
20140803	1.00 [10]
20140804	0.50 [R5]

Classic Pro XD gravity and 475 XTech

The best price/quality ratio in conventional primer spray guns.

A new body with improved ergonomics, the widest range of responses and application solutions and complies with the strictest safety standards and with the strictest standards on solvent emissions, distinguish the new model Classic Pro XD.

Single axis system, minimum parts.

One single piece automatic paint packing gland. No gaskets.

TECHNICAL DETAILS

- > Weight with deposit: 434 g
- > Dimensions: 34.5 x 10 x 18 cm
- > Air inlet coupling thread 1/4" male
- > Maximum air pressure: 8 bar
- > Maximum recommended inlet pressure: 2 bar
- > Maximum recommended application distance:
 - HVLP: max. 15 cm.
 - 21 EPA y 25/36/28: max. 18 cm.
- > Maximum paint flow output (nozzle 1.4 mm. 20"):
 - Aircap 21: 192 g/min
 - Aircap HVLP: 189 g/min
- > Air consumption:
 - Aircap HVLP: 280 L/min
 - Aircap 21 EPA: 240 L/min
 - Aircap 25/36/28: 320 L/min



Compact gravity spray gun, due to its small size it is ideal for feathering, small retouches, patches and/or repainting small parts.

Comes with a 125 cc. high quality deposit with paint filter.

Large variety of nozzle & needle and solutions



R5 Aircap

Special aircap R5: to obtain the maximum precision at the finest feathering. Definition and regulation. Similar to an airbrush. Nozzles of 0.5 mm.

05 Aircap: highest quality atomisation for feathering and retouch.

Nozzles & needle 0.5 and 0.8 mm.

10 Aircap: fast and versatile. Metallics and clearcoats. Nozzles & needle 1.0 mm.

TECHNICAL DETAILS

- > Weight with deposit: 330 g
- > Air inlet coupling thread 1/4" male
- > Maximum air pressure: 8 bar
- > Incorporates 100 mesh paint filter
- > Maximum recommended inlet pressure (working pressure): 2.0 - 3.0 bar
- > Air consumption: (at 3.0 bar inlet):
 - Aircap 05: 100 L/min
 - Aircap 10: 110 L/min
 - Aircap R5: 45 L/min

Automatic spray guns

- > **Customised solutions** for each product and spraying process.
- > Maximum **productivity**
- > Optimum **performance**
 - > Minimum mist.
 - > Easy to clean.
 - > Maximum **toughness**.
- > **Minimum maintenance**.

These are the basic premises upon which all SAGOLA automatic spray guns are designed.

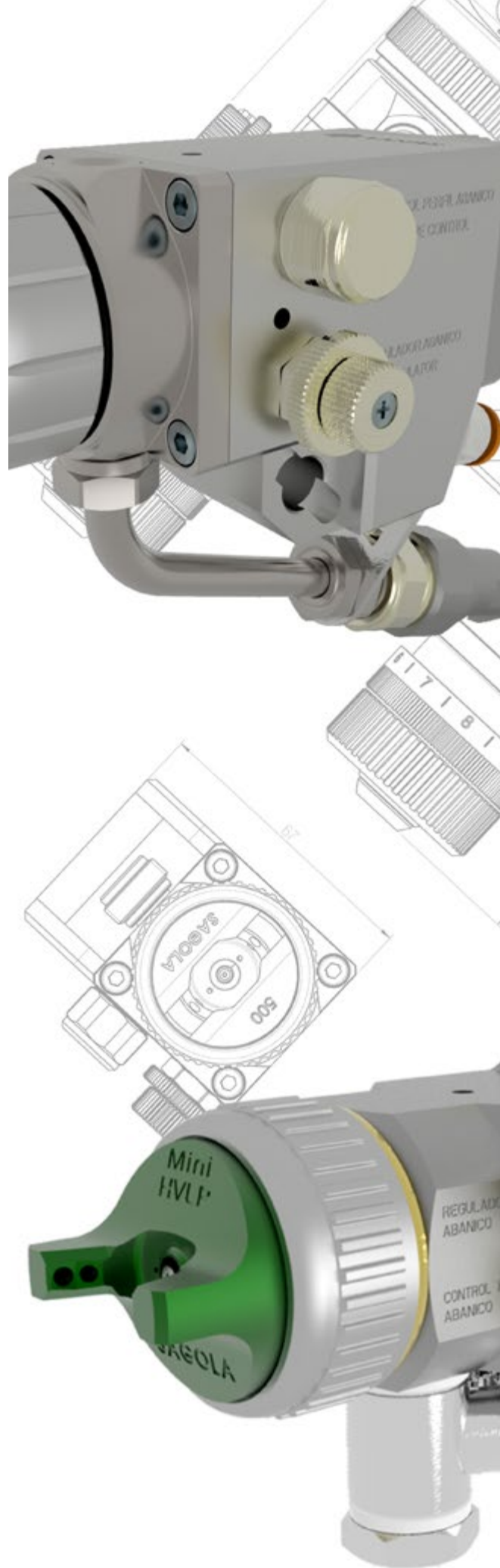

INDUSTRIAL PAINTING

Automatic spray guns

V series

Introduction

New range of automatic spray guns

Totally accurate regulation

New mounting and guidance systems

Significant advantages

The new V series of spray guns incorporates a new system of regulation allowing the achievement of better finishes and higher performance in any kind of application employing any kind of product.

The new V range of automatic spray guns has been designed and manufactured to carry out the very highest quality tasks. This new family of tools aims to cover a wide variety of product applications, including corrosive and abrasive products.

It is designed to work with both waterborne and solvent-based products. Its construction is characterised by the remarkably small number of parts that need maintenance, which makes it extremely reliable, keeping downtime to a minimum.

Versions

The new range embraces all known spray production systems: MEDIUM PRESSURE, HVLP, EPA and MIX.

Each one is available in multiple versions: special for corrosive products, abrasive products, special for robots, etc.

In a word, this new range of spray guns will cover all future production line painting needs.

**INNOVATION + TECHNOLOGY + PERFORMANCE =
MAXIMUM PRODUCTION + MINIMUM MAINTENANCE**

Automatic paint packing gland without gaskets that require handling

Made of stainless steel.

Nozzle and Needle

Made of stainless steel.
Optional Carbide.

Circulating paint outlet

Detachable paint-head

and independent from the pneumatic zone, with four leak detection holes between them, covering all possible angles. 100% stainless steel option.

Paint flow regulator

with integrated adjustable micrometer for a precise and homogeneous paint regulation of all the guns in the line.

Air inlets for atomization and operation

Fan regulator

This regulator allows us to adjust the size of the fan (of the atomisation air).

New mooring and guidance systems

This new system allows removal and replacement of the spray gun from its workstation, keeping always with the same orientation.



Waste time spent adjusting spray guns at their workstations is eliminated completely.

Fan control regulator

This regulator controls the quantity and distribution of air between the lugs and central holes, allowing a perfect distribution of the spray pattern independently of the viscosity of the product.

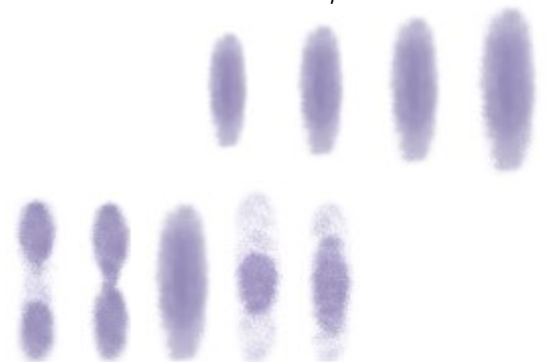

V4 and V5 HVLP

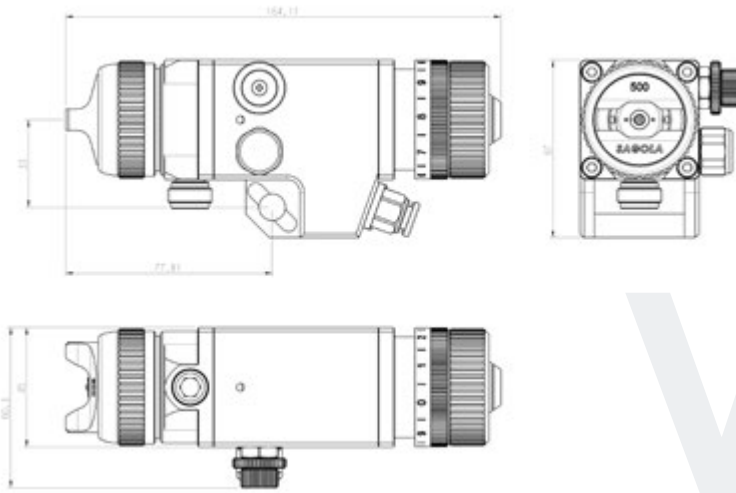

V4

V4

Maximum speed of application

Allows working with high paint flows

Stainless steel head versions for corrosive products and tungsten carbide nozzles for abrasives

* See CODES on page 52

High production conventional spray gun. Incorporates double fan regulator and product regulator.

In the standard version, the nozzle and the needle are made of stainless steel.

Applications

- > For tasks requiring a high opening and closure rate. Ideal to be used with robots and special machinery.
- > Versions for highly corrosive or abrasive products (with tungsten carbide needle and nozzle).
- > Special for high speed and top quality finishes.

Application Sectors

Metal Industry - Plastic Industry - Automotive Industry - Ceramics

TECHNICAL DETAILS

- > Dimensions: 164 x 45 x 104 mm
- > Weight: 785 g
- > Air consumption: 350 - 400 L/min
- > ATEX 2 II GX



Standard version

V5

V5 HVLP

Maximum reduction in product consumption and mist

High speed application

Stainless steel head versions for corrosive products and tungsten nozzles for abrasives

* See CODES on page 52

This is the ideal tool where very high application speed along with significant reduction of product consumption are required. Spray mist, pollution, dirt and noise are all greatly reduced, thus improving work conditions.

The high production spray gun incorporates a double spray pattern regulator, product regulator and stainless steel nozzle and needle in the standard version.

Applications

- > For tasks requiring a high opening and closure rate. Ideal to be used with robots and special machinery.
- > Versions for highly corrosive or abrasive products (with tungsten carbide needle and nozzle).

- > For tasks where it is necessary to reduce mist and improve work conditions.
- > Achieves a drastic reduction in product consumption.

Application Sectors

Furniture Industry - Automotive Industry - Plastics - Ceramic - Textile - Tannery

TECHNICAL DETAILS

- > Spray pressure at aircap: 0.68 bar
- > Dimensions: 164 x 45 x 104 mm
- > Weight: 785 g
- > Air consumption: 500 - 600 L/min
- > ATEX 2 II GX



INDUSTRIAL PAINTING

Automatic spray guns

V Series

V6 EPA and V7/Mix

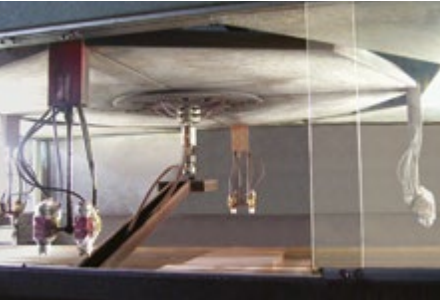

V6

Maximum finish quality with waterborne or solvent-based products

Maximum mist and product consumption reductions

Very low air consumption. Works at very low pressures

* See CODES on page 52

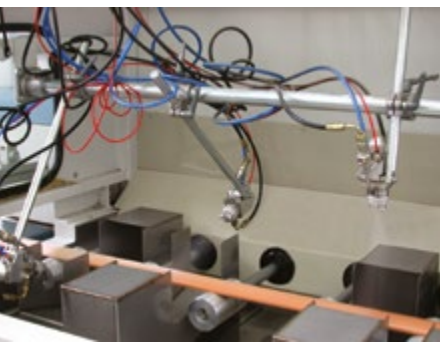

V7 Mix

High production, low pollution

Maximum speed of application

High paint pressure mix system (30-150 bar)

Low air pressure: 0.5 - 2 bar

* See CODES on page 52



EPA spray system with a minimum product transfer of 65%.

Savings of paint supply, reduction of mist.

Stainless steel nozzle and needle, product regulator, double fan regulator....

Applications

- > For tasks requiring a high opening and closure rate. Ideal to be used with robots and special machinery.
- > Versions for highly corrosive or abrasive products (with tungsten carbide needle and nozzle).
- > For tasks where it is necessary to reduce mist and improve work conditions.

- > Achieves a drastic reduction in product consumption.
- > For all applications where the very highest quality finish is required.

Application Sectors

Furniture Industry - Automotive Industry - Plastics Industry - Textiles - Stains

TECHNICAL DETAILS

- > Dimensions: 164 x 45 x 104 mm
- > Weight: 785 g
- > Air consumption: 380 L/min
- > ATEX  2 II GX



- > Spraying of clearcoats, UV paints, etc.

Application Sectors

Furniture Industry - Metal Industry - Plastic Industry

TECHNICAL DETAILS

- > Working pressure: 30/150 bar
- > Minimum operational pressure: 3.5 bar
- > Dimensions: 164 x 45 x 104 mm
- > Weight: 945 g.
- > Air consumption: 150 L/min.
- > ATEX  2 II GX



**INNOVATION + TECHNOLOGY + PERFORMANCE =
MAXIMUM PRODUCTION + MINIMUM MAINTENANCE**

Catalogue 2020

INDUSTRIAL PAINTING

Automatic spray guns

Mini V V Series

Nozzle and Needle

Made of stainless steel.

Automatic paint packing gland without gaskets that require handling

Made of stainless steel.

Product regulator

High precision.

Fan regulator

This regulator allows us to adjust the size of the fan (of the atomisation air).

Fan control regulator

This regulator controls the quantity and distribution of air between the lugs and central holes, allowing a perfect distribution of the spray pattern independently of the viscosity of the product.

TECHNICAL DETAILS

- > Weight: 216 g
- > Dimensions: 32 x 50 x 90 mm
- > Paint inlet: BSP 1/8"
- > Spray air inlet: ø 8mm
- > Cylinder air inlet: ø 4mm
- > Air consumption:
 - Mini HVLP: 310 l/min
 - Mini EPA: 200 l/min
- > ATEX  2 II GX



Mini V

Automatic gun, small size and high precision.

With internal valve

0,3 – 1,80 mm. fluid nozzles.

Mini Xtreme spraying system.

Wide regulation range; paint flow, fan, and pattern shape.

Suitable for small parts painting, and machinery with reduced spaces

HVLP and EPA high transfer aircaps.

Extensions

See options in page 84



HVLP System
75% Transfer

Mini HVLP



EPA System
65% Transfer

Mini EPA



Round Jet System

Chorro redondo



EPA System
65% Transfer

Aero Jet



Code

Version

10210217	0.30 [Mini HVLP]
10210208	0.50 [Mini HVLP]
10210201	0.80 [Mini HVLP]
10210202	1.00 [Mini HVLP]
10210203	1.20 [Mini HVLP]
10210204	1.30 [Mini HVLP]
10210205	1.40 [Mini HVLP]
10210206	1.60 [Mini HVLP]
10210207	1.80 [Mini HVLP]
10210218	0.30 [Mini EPA]
10210216	0.50 [Mini EPA]
10210215	0.80 [Mini EPA]
10210209	1.00 [Mini EPA]
10210210	1.20 [Mini EPA]
10210211	1.30 [Mini EPA]
10210212	1.40 [Mini EPA]
10210213	1.60 [Mini EPA]
10210214	1.80 [Mini EPA]
10210219	0.60 [Mini TECH]
10210220	1.00 [Mini TECH]
10210221	0.50 [Mini Aero Jet]



INDUSTRIAL PAINTING

Automatic spray guns

V Series

Versions and applications



All models in the V series may be customised according to the requirements of the required application. This chart shows standard versions and the optional nozzle and needle combinations with different aircaps and their main features. The data is organised as follows:

Features		V4 Standard	V5 HVLP	V6 EPA	V7 MIX				
Standard	Aluminium head Stainless steel nozzle and needle	10250801	0.80 [765]	10210401	0.80 [500]	10280101	0.80 [380]	35230101	13/40 [3]
		10250802	1.00 [765]	10210402	0.80 [600]	10280102	1.00 [380]		
		10250803	1.00 [777]	10210403	1.00 [500]	10280103	1.20 [380]		
		10250805	1.20 [20]	10210404	1.00 [600]	10280104	1.40 [380]		
		10250806	1.20 [765]	10210405	1.20 [500]				
		10250808	1.20 [797]	10210406	1.20 [600]				
		10250809	1.40 [20]	10210407	1.40 [600]				
		10250810	1.40 [765]						
		10250811	1.80 [20]						
Corrosive products	Stainless steel head Stainless steel nozzle and needle	10250812	0.80 [765]	10210408	0.80 [500]	10280105	0.80 [380]		
		10250813	1.00 [765]	10210409	0.80 [600]	10280108	1.40 [380]		
		10250814	1.00 [777]	10210410	1.00 [500]	10280124	1.80 [380]		
		10250815	1.00 [797]	10210411	1.00 [600]				
		10250816	1.20 [20]	10210412	1.20 [500]				
		10250819	1.20 [797]	10210414	1.40 [600]				
		10250820	1.40 [20]	10210415	1.80 [600]				
		10250821	1.40 [765]						
		10250824	2.80 [62]						
Abrasive products	Stainless steel head Tungsten Carbide nozzle and needle	10250825	1.20 [765]	10210416	1.20 [500]				
		10250827	1.40 [765]	10210418	1.40 [600]				
		10250828	1.80 [67]						
		10250829	2.20 [64]						
		10250830	2.80 [62]						
Standard Robot	Aluminium head Stainless steel nozzle and needle Robot	10250831	0.80 [765]	10210419	0.80 [500]	10280111	0.80 [380]	35230102	13/40 [3]
		10250832	1.00 [765]	10210421	1.00 [500]	10280114	1.40 [380]		
		10250834	1.00 [797]	10210423	1.20 [500]				
		10250835	1.20 [20]	10210424	1.20 [600]				
		10250838	1.20 [797]	10210425	1.40 [600]				
		10250839	1.40 [20]						
		10250840	1.40 [765]						
Corrosive products Robot	Stainless steel head Stainless steel nozzle and needle Robot	10250842	0.80 [765]	10210427	0.80 [600]	10280115	0.80 [380]		
		10250844	1.00 [777]	10210430	1.20 [500]	10280116	1.00 [380]		
		10250845	1.00 [797]	10210431	1.20 [600]	10280117	1.20 [380]		
		10250846	1.20 [20]	10210432	1.40 [600]	10280118	1.40 [380]		
		10250848	1.20 [777]	10210433	1.80 [600]				
		10250849	1.20 [797]						
		10250850	1.40 [20]						
		10250851	1.40 [765]						
		10250852	1.80 [20]						
		10250853	2.20 [64]						
		10250854	2.80 [62]						
Abrasive products Robot	Stainless steel head Tungsten Carbide nozzle and needle Robot	10250855	1.20 [765]	10210434	1.20 [500]	10280119	1.20 [380]		
		10250856	1.40 [78]	10210435	1.20 [600]				
		10250857	1.40 [765]	10210436	1.40 [600]				
		10250858	1.80 [67]						
		10250859	2.20 [64]						
		10250860	2.80 [62]						

* Consult more options.

PRODUCT APPLICATION GUIDES	V4 Standard	V5 HVLP	V6 EPA	V7 MIX
Liquid products, Wood, textile and tannery dyes, Teflon	1.0 [765]	0.8 [500] 0.8 [600] 1.0 [500]	0.8 [380] 1.0 [380]	
Special for double-coat finishes: metallics and pearls finishes for the automotive and plastics industries	1.0 [777] 1.2 [777]	0.8 [500] 1.0 [600] 1.2 [600]	1.0 [380] 1.2 [380]	
Special for HS finishes, HS single stage and clearcoats. Auto industry, plastics, wood	1.0 [797] 1.2 [797]	1.0 [500] 1.2 [600]	1.2 [380]	0.009 [3] 0.001 [3]
Finishes in general; Paints, clearcoats for the wood and metal industries	1.2 [765] 1.4 [765] 1.2 [777]	1.0 [500] 1.2 [500] 1.2 [600]	1.0 [380] 1.2 [380]	0.009 [3] 0.011 [3] 0.013 [3]
Primers, basecoats, sealants, fillers for the wood and metal industries	1.2 [765] 1.4 [765]	1.2 [500] 1.2 [600] 1.4 [600]	1.2 [380] 1.4 [380]	0.013 [3] 0.015 [3] 0.018 [3]
Abrasive products - ceramic paints - paints for glazing - for the ceramics and vitro-ceramics industries	1.4 [78] CT. 1.8 [67] CT. 2.2 [64] CT. 2.8 [62] CT.	1.2 [500] CT. 1.2 [600] CT. 1.4 [600] CT.	1.4 [380] CT.	
Glues, adhesives	1.2 [20] 1.4 [20] 1.8 [20]	1.2 [500] 1.4 [600]	1.4 [380]	



**450 A HVLP,
4200 A EPA and 4041**

450 A HVLP

Great product savings

High production version available

Application Sectors

Furniture Industry
Automotive Industry - Plastics Industry - Ceramics

Code	Version	Application
10210303	1.00 [500]	Liquid products, dyes and metallized products
10210304	1.20 [500]	Finishes, basecoats and primers. Metal and wood.
10210307	1.20 [600]	High speed application
10210309	1.20 [3030]	Primers, basecoats
10210310	1.40 [3030]	Primers, high micronage, low mist

HVLP automatic spray gun which complies with the strictest environmental norms and standards due to its 72% + transfer.

Constructed especially for automatic systems where a very high rate of open - close cycles is required.

It is also recommended where considerable spray mist reduction is required.

Durable: low maintenance costs.



TECHNICAL DETAILS

- > Air consumption: 540 L/min. (500), 600 L/min. (600), 400 L/min. (3030)
- > Spray pressure at aircap: 0.68 bar
- > Operating pressure: min. 4 bar
- > Dimensions: 152 x 83 x 73 mm
- > Weight: 710 g
- > ATEX 2 II GX



4200 A EPA

Lower air consumption than conventional spray guns

Application Sectors

Furniture Industry
Automotive Industry
Plastics Industry

The 4200A is an automatic high production EPA spray gun with a minimum transfer of 65%.

Stainless steel nozzle, needle and paint packing nut.

Extremely high finish quality.

Code	Version	Application
10250701	1.00 [380]	Highest quality finishes
10250702	1.20 [380]	Finishes, primers

TECHNICAL DETAILS

- > Air consumption: 380 L/min.
- > Operating pressure: min. 4 bar
- > Dimensions: 152 x 83 x 73 mm
- > Weight: 710 g
- > ATEX 2 II GX



4041

Special for finishes



Conventional spray gun ideal for robots and special machinery.

Special nozzles in tungsten carbide for abrasive products.

Application Sectors

Metal - Plastic - Automotive - Ceramics

Code	Version	Application
10250305	1.20 [765]	Extremely high finish quality

TECHNICAL DETAILS

- > Air consumption: 370 L/min
- > Dimensions: 152 x 83 x 73 mm
- > Weight: 710 g
- > ATEX 2 II GX



INDUSTRIAL PAINTING

Automatic spray guns

Other versions

4041 Mix, V2 PD, 4098 and PSAA 108



4041 Mix

Maximum speed of application

Medium paint pressure (30-150 bar)

Minimum mist

Code

35230401

Compact and robust automatic mix system spray gun.

Tungsten Carbide closures.

Application Sectors

Furniture - Metal - Wood

TECHNICAL DETAILS

- > Air consumption: 150 L/min.
- > ATEX  2 II GX



V2 PD

Maximum transfer

Nozzle 6 mm.

Road signs

Code

10259203

Special automatic spray gun for road signage painting machinery.

Internal mixing nozzle.

Valid for high viscosity products.



4098

Special for clears, ceramics and abrasives

Spray gun designed for the application of ceramic products and abrasive paints.

Product closure is accomplished using a membrane system. Due to its small size and weight it can be installed in places of restricted space.

TECHNICAL DETAILS

- > Dimensions: 70 x 90 x 110 mm
- > ATEX  2 II GX



Code

10250601

Version

1.40 [765]

PSAA 108

Automatic airless spray gun

To use with all types of medium and high viscosity products

Code

30270101

Anodized aluminium body. Operation by means of pneumatic cylinder. Tungsten carbide closure.

TECHNICAL DETAILS

- > Maximum product pressure: 400 bar
- > 1/4" product inlet coupling
- > ATEX  2 II GX



Industrial Air Filtration Systems

New challenges in painting (new waterborne paints), more tools in the industry and more demanding productivity constantly increase the importance of the **reliability of the compressed air network.**

The appearance of new regulations regarding the drastic reduction of solvents in the new paints means that the existence of impurities in the air system is more and more critical to the final result of satisfactory finishes.

With the sole **objective of achieving the maximum degree of finish** and gloss, we at SAGOLA have applied ourselves wholeheartedly to developing **our 5000X line of filters.**

We have endowed all the models (5000X and 5100X) with the latest purification and regulation technology and performance, offering the industry all the possible responses at the most important point: inside the spray painting booth.

Additionally, SAGOLA offers its **renewed PLUS range of filters, regulators and lubricators** with a new compact, robust design for efficiency and smooth handling, and the best price-quality ratio on the market.



INDUSTRIAL PAINTING

Filtration system

Purifying filter

5000X series

5300X and 5200X filters



5300X

Coalescent Filter Regulator
Purifier Filter (0.01 microns) +
wide surface active charcoal

Ideal for waterborne and HS paints

Solutions for lines with organic
fumes in the network

Very high quality finishes

Minimum loss of pressure

Double outlet



Wide surface filtration elements

Maximum quality of
manufacturing processes

Materials and mechanization

Special for waterborne and HS
paints

Maximum flow 2,500 L/min

Very smooth working

Maximum precision

Maximum air filtration quality

Quick couplings with mechanisms

made of stainless steel

Silicone free joints

Model	Code	Versión
5300X	10730305	US-Mil
	10730351	Nitto
	10730308	Euro-profile

Model 5300X offers the maximum filtration level in spray booths and painting lines with high quality air demand.

Ideal for waterborne paint and where organic fumes in the network are a problem.

Sinterised brass **8 micron** pre-filtration is incorporated, followed by a **0.01 micron** coalescent filter and final filtration by a **wide surface active charcoal filter**.

In addition to water and impurities, this process eliminates organic fumes and foul air.

TECHNICAL DETAILS

- > Air flow: 2,500 L/min
- > Air inlet: 1/2" BSP
- > Air outlet: 1/4" BSP
- > Maximum working pressure: 12 bar
- > Maximum temperature resistance 90°C
- > Automatic + 2 semi-automatic drain systems



5200X

Model	Code	Version
5200X	10730304	US-Mil
	10730350	Nitto
	10730307	Euro-profile



Other characteristics are the automatic drain system and the regulator with regulation wheel.

Its **NEW VESSELS** are tougher and more protective.

Its **NEW DRAINING SYSTEM** reduces maintenance costs due to its greater durability. It carries out double filtration with optimum flow and pressure regulation, retention of water and impurities attaining an air purity of 99%.

TECHNICAL DETAILS

- > Air flow: 2,500 L/min
- > Air inlet: 1/2" BSP
- > Air outlet: 1/4" BSP (USMil couplings)
- > Maximum working pressure: 12 bar
- > Maximum temperature resistance 90°C
- > Automatic + semi-automatic drain system

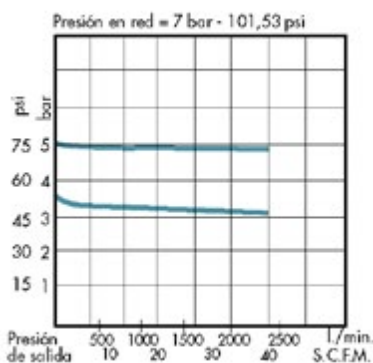

Model 5200X offers the highest technology for air filtration. It incorporates an **8 micron** sinterised brass filter, followed by a final **0.01 micron** coalescent filter.



5100X and 5000X filters

5100X

Valid for HS paints and highest quality finishes

Regulator filter with new vessel

Minimum pressure loss

Double outlet

Code

10730202

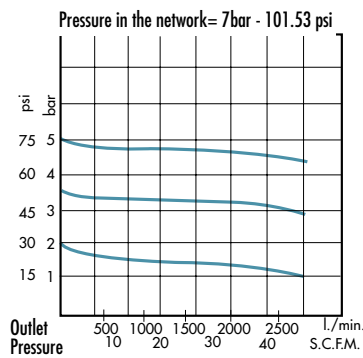

Air purifying filter with pressure regulator and pressure gauge.

Its NEW VESSEL is tougher and more protective.

Model 5100X comes with a NEW DRAINING SYSTEM which reduces maintenance costs due to its greater durability.

It incorporates an 8 micron sinterised brass filter.

Air-assisted regulator. Wide surface filtration elements. Maximum manufacturing quality in materials and machining

Special for waterborne and HS paints

Extremely smooth action. Maximum precision.

Maximum quality in air filtration.

Push connectors with stainless steel mechanisms and silicone-free gaskets. Automatic-draining system and air assisted regulator.



TECHNICAL DETAILS

- > Air flow: 2,500 L/min.
- > Air inlet: 1/2" BSP
- > Air outlet: 1/4" BSP
- > Maximum working pressure: 12 bar
- > Maximum temperature resistance: 90°C



5000X

Valid for highest quality finishes

Code

10730204

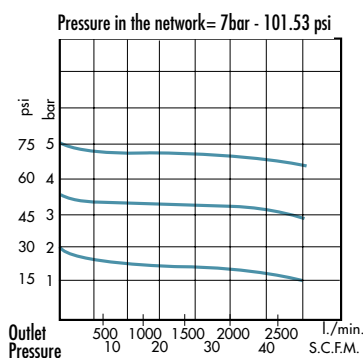

Air purifying filter with pressure regulator and pressure gauge.

Its NEW VESSEL is tougher and more protective.

The 5000X model incorporates a semi-automatic draining system.

TECHNICAL DETAILS

- > Air flow: 2,500 L/min
- > Air inlet: 1/2" BSP
- > Air outlet: 1/4" BSP
- > Maximum working pressure: 12 bar
- > Maximum temperature resistance: 90°C



INDUSTRIAL PAINTING
Filtration system
Purifying filter
4000 series

4120 Plus and 4220 Plus filters



4120

4120 PLUS

Effective solution for compressed air filtration in professional paint booths

Effective solution for compressed air filtration in professional paint booths for: car refinish, wood, machinery, plastics and industry in general.

Highly reliable air regulation system. Manufactured from a solid aluminum block.

It eliminates air, oil and particles. Friction and centrifugal filtration.

Automatic drain of condensed liquids. High air flow. High quality manometer.



Modelo	Código	Versión
4120	10730501	-
4120 PLUS (includes coupling)	10730502	US-Mil
	10730503	Nitto
	10730504	Euro-profile

TECHNICAL DETAILS

- > Dimensions 4120: 279 x 117 x 69.5 mm.
- > Dimensions 4120 PLUS: 279 x 117 x 96 mm.
- > Weight: 4120: 1,015 g. 4120 PLUS: 1,220 g.
- > Brass filter: 20 microns
- > Drain system: automatic
- > Air flow: 1,700 l/min.
- > Maximum pressure: 12 bar
- > Air inlet: 1/2"
- > Coupling 4120 PLUS: SAGOLA US Mil



4220

4220 PLUS

Recommended for last generation finishes

Two stage air filter. Maximum filtering level. Recommended for last generation finishes.

Waterborne paints, HS clearcoats and enamels, high gloss lacquers

Highly reliable air regulation system. Manufactured from a solid aluminum block.

1st stage: water, oil and particles filtering + 2nd stage: submicronic filtering. 0.01 microns Automatic drain of condensed liquids. High air flow. High quality manometer.



Model	Code	Version
4220	10750401	-
4220 PLUS (includes coupling)	10750402	US-Mil
	10750403	Nitto
	10750404	Euro-profile

TECHNICAL DETAILS

- > Dimensions 4220: 279 x 117 x 162 mm.
- > Dimensions 4220 PLUS: 279 x 117 x 186 mm.
- > Weight: 4220: 1,797 g. 4220 PLUS: 2,002 g.
- > Brass filter: 20 microns + Coalescent filter: 0.01 microns
- > Drain system: automatic + semi automatic
- > Air flow: 1,700 l/min.
- > Maximum pressure: 12 bar
- > Air inlet: 1/2"
- > Coupling 4220 PLUS: SAGOLA US Mil



**479 Plus, 970 Plus, 430 Plus,
439 Plus and 437 Plus**

**479
PLUS**

The most compact solution for the small workshops, industry or priming and preparation areas

Code	Version
10730401	1/2"
10730402	3/8"
10730403	1/4"



TECHNICAL DETAILS

- > Dimensions: 229 x 73 x 115 mm
- > Weight: 886 g
- > Brass filter: 40 microns
- > Air flow: 1,700 L/min
- > Couplings: 1/2", 3/8", 1/4"
- > Max. working pressure: 10 bar
- > Draining system: semi-automatic



**970
PLUS**

Assure the supply of clean and properly lubricated air to tools and pneumatic engines

Code	Version
10750301	1/2"
10750302	3/8"
10750303	1/4"



TECHNICAL DETAILS

- > Dimensions: 229 x 148 x 115 mm
- > Weight: 1,450 g
- > Brass filter: 40 microns
- > Air flow: 1,700 L/min
- > Connections: 1/2", 3/8", 1/4"
- > Max. working pressure: 10 bar
- > Draining system: semi-automatic



Large air flow, highly reliable regulating system, high quality pressure gauge, the best materials. Adaptable to any size of hose. Great filtration capacity with check window for waste particle and semi-automatic drain system.

It supplies clean, lubricated air to all your tools. Accurate control of the oil content by means of a "drop-by-drop" hand regulator.



**430
PLUS**

Small, sturdy, reliable and long lasting

Mini air regulator. Diaphragm regulator from 0 to 10 bar.

TECHNICAL DETAILS

- > Dimensions: 107 x 65 x 115 mm
- > Weight: 544 g
- > Air flow: 1,200 - 1,700 L/min
- > Couplings: 1/2", 3/8", 1/4"
- > Max. working pressure: 10 bar

Code	Version
10740501	1/2"
10740502	3/8"
10740503	1/4"



**439
PLUS**

High-durability
Maximum robustness

Code	Version
10720401	1/2"
10720402	3/8"
10720403	1/4"

High flow filter for insertion in air lines. Check window for waste liquids. Semi-automatic drain system.

Suitable for all type of installations, accessories included.



TECHNICAL DETAILS

- > Dimensions: 158 x 73 x 73 mm
- > Weight: 553 g
- > Brass filter: 40 microns
- > Air flow: 1,700 L/min
- > Couplings: 1/2", 3/8", 1/4"
- > Max. working pressure: 10 bar
- > Draining system: semi-automatic



**437
PLUS**

Minimum flow
restrictions

Code	Version
10710301	1/2"
10710302	3/8"
10710303	1/4"

Ideal for the proper lubrication of pneumatic tools. Manual oil regulator by level check window, drop by drop system. CNC mechanized from a solid aluminium block.

TECHNICAL DETAILS

- > Dimensions: 165 x 73 x 73 mm
- > Weight: 482 g
- > Oil filter
- > Air flow: 1,920 L/min
- > Couplings: 1/2", 3/8", 1/4"
- > Max. working pressure: 10 bar



INDUSTRIAL PAINTING
Filtration system
Air treatment

Air quality test equipment
Filter accessories and complements

Air quality test equipment

Easy to use

High precision

Code

15020001

Code

49000740

Version

membrane filter kit,
pore 0.45 (50 units)

Equipment for the detection of air impurities, humidity level and temperature.

It incorporates air quality test equipment with inlet regulator, flashlight with magnifying glass of 30 magnification for visualization of impurities, humidity meter and digital temperature.

It incorporates membrane filter kit, pore 0.45 (50 pcs).



ACCESSORIES AND COMPLEMENTS Air filtration systems

Coalescent filter kit (1 unit)

Optimum service life: 6 months

Code

56418071

Model

5200X, 5300X



Active charcoal filter kit (1 unit)

Optimum service life: 3 months

Code

56418070

Model

5300X



Timer for filters (5000X series)

The Time Indicators offer a helpful visual reminder of maintenance programs of our filters.
 The timer is included in each kit filter.
 - 3-month timer
 - 6-month timer

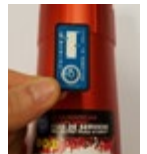

Sinterised brass filter kit (1 unit)

Optimum service life: 6 months

Code

56418719

Model

5050X, 5100X, 5200X, 5300X



Optional Double outlet Kit

Quick couplings SAGOLA US Mil series. Models: 4120, 4220, 5000X, 5050X.

Code

56418704



Automatic drain

Models: 4120, 4220, 5100X

Code

56450010



Spare part for air filter-regulator

5000X model

Code

56418720



Sinterized brass filter 20 microns

4120 PLUS and 4220 PLUS

Code

56418721



Coalescent filter 0.01 microns

4220 and 4220 PLUS

Code

56418722

Vessel Kit + Automatic drain

4000 series

Code

56417711

Version

4120 PLUS

56417712

4220 PLUS

Semi-automatic drain valve

4000 series

Code

56417507

Pressure gauge

Code

54550016

Model

Serie 5000X



Gasket Kit

4000 series

Code

56418587

Version

4120 PLUS

56418588

4220 PLUS

Anti-static air hoses

See "Compressed Air Complements" (page 65)



Filter 4000 range Display

4220 Plus model

Code

70000007



Compressed air hoses Compressed air complements

- > **Wide range of push connectors and plugs:**
 - US MIL, EURO PROFILE, MULTI PROFILE and NITTO
 - High quality, safety, anti-shock....
 - > **Air and Paint Hoses**
 - > **High and low pressure hoses**
 - > For mix, airless and aerographic spray guns

SAGOLA invests the maximum care in this range because we know that you can not take risks with pressure equipment.

General application spray guns

A wide range of **pneumatic tools** as a **complement to the paint line** in industrial workshops:

- > **Blowers and Sealants.**
- > Guns for **adhesives bead** application and textured products.

Sanding system

Low air consumption pneumatic rotary orbital sanders.

- > Work with the maximum cleanliness, assuring that all the sanding dust is properly collected.

Personal Protection

Protective masks for sanding and painting processes, anti-static painters' overalls...

One of SAGOLA's main concerns is to assure optimum, safe working conditions for all.

Waste Management System

Why increase waste disposal costs of paint cans, paper and cardboard because you can not reduce their volume?

We at SAGOLA understand the importance of proper management of the residues generated by paints and solvents in industry and the high costs these imply in the running of a business. In this section we offer two important product lines to drastically reduce these costs.

- > **Can, paper and cardboard crushers**
 - Robust
 - Safe and easy to use



INDUSTRIAL PAINTING

Compressed air
Compressed air
complements

Quick couplings and connectors

FEATURES NEW RANGE

Couplings and connectors



Max. pressure: 25 bar
Europerfil max. pressure: 15 bar
Aluminum plugs max. pressure: 20 bar

The new range of plugs SAGOLA presents cutting-edge design. SAGOLA offers a wide range that gives cover 100% of market requirements. Is incorporated security versions. All steel and aluminum plugs are BSP; Males (BSPT) and females (BSPP).

Plug body made of treated steel and valve made of brass. So a guaranteed life of more than 1,500,000 uses. The new range of plugs SAGOLA incorporates a handle made of composite, which gives a high resistance to both attrition and drag. Attrition resistance tested in more than 48,000 impacts and the equivalent to a crawl 12 km.

1. SHOOTER made of composite with a weight reduction and extraordinary durability against impact (48,000 impacts test).

2. BODY PLUG made of steel with anticorrosive treatment.

3. VALVES Brass valve manufactured, specific to work at high temperatures.

4. JOINTS Nitrile Butadiene. Operating temperature range: -20°C +100°C.

5. PINS made of tempered high strength steel that guarantees the absence of attrition.

6. SPRING made of stainless steel.



The quick couplings are supplied in individual blister packs

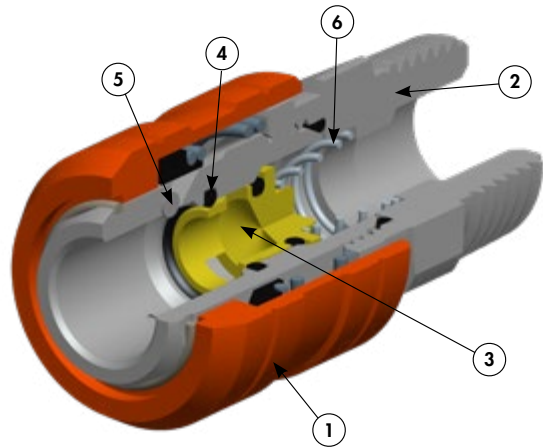

Ultra-Light range. Ultra-light weight. 45 g.

US-Mil range

ULTRA LIGHT

US-Mil RANGE

Flow: 68 m³/h. - 1,133 L/min.
Body and shooter made of high strength aluminum. Valve made of brass. Pins made of high strength steel.
Air coupling: 1/4"



Code	Version
11010531	BSPT 1/4"



Code	Version
11010431	BSPP 1/4"



Code	Version
11010629	Barb. 8 mm.

US-Mil range

Air coupling: 1/4" Flow: 68 m³/h. - 1,133 L/min.

US-Mil RANGE

Simple shutter plug, made of hardened steel with gasket made of Nitrile Butadiene. Its excellent sealing prevent dirt penetrates inside. High strength sleeve.



Code	Version
11010524	BSPP 1/4"
11010525	BSPP 3/8"
11010526	BSPP 1/2"



Code	Version
11010424	BSPP 1/4"
11010425	BSPP 3/8"
11010426	BSPP 1/2"



Code	Version
11010624	Espiga 8 mm.
11010625	Espiga 10 mm.

Code	Version
11010527	BSPP 1/4"
25 units	

Code	Version
11010427	BSPP 1/4"
25 units	

Code	Version
11010626	Barb. 8 mm.
25 units	

US-Mil range

SAFETY Plug

Air coupling: 1/4" Flow: 68 m³/h. - 1,133 L/min.

US-Mil RANGE

Plug with gasket made of Nitrile Butadiene and double effect opening. Anti-whiplash safety plug according to ISO-4414. Two movements "push-pull" to disconnect.
High strength sleeve.



Code	Version
11010528	BSPT 1/4"
11010529	BSPT 3/8"
11010530	BSPT 1/2"



Code	Version
11010428	BSPP 1/4"
11010429	BSPP 3/8"
11010430	BSPP 1/2"



Code	Version
11010627	Barb. 8 mm.
11010628	Barb. 10 mm.



Quick couplings

Air coupling: 7.6 mm. Flow: 85 m³/h. - 2,000 L/min.

Euro-Profile range

Quick coupling

Euro Profile RANGE

Simple shutter plug, made of hardened steel with gasket made of Nitrile Butadiene. Its excellent sealing prevent dirt penetrates inside.



Code	Version
11010823	BSPT 1/4"
11010824	BSPT 3/8"
11010825	BSPT 1/2"



Code	Version
11010723	BSPP 1/4"
11010724	BSPP 3/8"
11010725	BSPP 1/2"



Code	Version
11010924	Barb. 8 mm.
11010923	Barb. 10 mm.

Euro-Profile range

SAFETY Plug

Air coupling: 7.6 mm. Flow: 85 m³/h. - 2,000 L/min.

Quick coupling

Euro Profile RANGE

Plug with gasket made of Nitrile Butadiene and double effect opening. Anti-whiplash safety plug according to ISO-4414. Two movements "push-pull" to disconnect. High strength sleeve.



Code	Version
11011323	BSPT 1/4"
11011324	BSPT 3/8"
11011325	BSPT 1/2"



Code	Version
11011423	BSPP 1/4"
11011424	BSPP 3/8"
11011425	BSPP 1/2"



Code	Version
11011523	Barb. 8 mm.
11011524	Barb. 10 mm.

Multi-Profile range

3x1 system. Compatibility: US-MIL/EUROPROFILE/ITALIANO PROFILE

Quick coupling

Multi-Profile RANGE

Flow: 85 m³/h. - 2,000 L/min. Simple shutter plug, made of steel with gasket made of Nitrile Butadiene. Its excellent sealing prevent dirt penetrates inside. Air coupling: 8 mm.



Code	Versión
11010826	BSPT 1/4"
11010827	BSPT 3/8"



Code	Versión
11010726	BSPP 1/4"
11010727	BSPP 3/8"



Code	Versión
11010925	Barb. 8 mm.
11010926	Barb. 10 mm.

Nitto range

ASIA-PACIFIC MARKET EXCLUSIVE PROFILE

Quick coupling

Nitto RANGE

Flow: 85 m³/h. - 2,000 L/min. Simple shutter plug, made of steel with gasket made of Nitrile Butadiene. Its excellent sealing prevent dirt penetrates inside. Air coupling: 8 mm.



Code	Versión
11011701	BSPT 1/4"
11011702	BSPT 3/8"



Code	Versión
11011801	BSPP 1/4"
11011802	BSPP 3/8"



Code	Versión
11011901	Barb. 8 mm.
11011902	Barb. 10 mm.

US-Mil range

BRASS Plug

Quick coupling

US-Mil RANGE-Spec C-4109

600 L/min. Versatile. Simple blocking plug made of brass with Buna N gasket. Its excellent sealing avoids the penetration of impurities to the inside. Fully compatible with earlier lines of SAGOLA plugs.



Code	Version
11010520	BSPP 1/4"
11010521	BSPP 3/8"
11010522	BSPP 1/2"



Code	Version
11010420	BSPP 1/4"
11010421	BSPP 3/8"
11010422	BSPP 1/2"



Code	Version
11010621	Barb. 8 mm.
11010622	Barb. 10 mm.

Code	Version
11010523	BSPP 1/4"
25 units	

Code	Version
11010423	BSPP 1/4"
25 units	

Code	Version
11010623	Barb. 8 mm.
25 units	

INDUSTRIAL PAINTING

Compressed air
Compressed air
complements

Quick Couplings, Threaded Couplings

FEATURES

Couplings and connectors

SIZE 2

The size 2 plug is the most commonly used push plug in paint and body shops, and also in industry for the connection of all kinds of pneumatic tools. Silicone free.
All springs, valves and pins made of stainless steel. All SAGOLA connectors are manufactured in high carbon steel making them extremely strong and stress resistant.

US-Mil range

Connector without blocker, made of steel.

Quick coupling

US-Mil-Spec C-4109 RANGE
(2 units) ID 5.5 mm.
Fully compatible with earlier lines of SAGOLA plugs. Made of high-carbon steel. Anti-corrosive nickel etched finish. Connector without blocker.



Code	Version
11020420	BSPT 1/4"
11020421	BSPT 3/8"
11020422	BSPT 1/2"
Code	Version
11020423	BSPT 1/4"
50 units	



Code	Version
11020520	BSPP 1/4"
11020521	BSPP 3/8"
11020522	BSPP 1/2"
Code	Version
11020524	BSPP 1/4"
50 units	



Code	Version
11020621	Barb. 8 mm.
11020622	Barb. 10 mm.
Code	Version
11020623	Barb. 8 mm.
50 units	

Orientable quick coupling
with exclusive rotating dial system, for greater freedom of movement.



Code	Version
11020523	BSPP 1/4"



Euro-Profile range

Maximum performance and durability in high production workshops.

Quick coupling

Euro Profile RANGE (2 units)
High flow. ID 7-8 mm.
Made of high-carbon steel.
Anti-corrosion blue galvanized finish. Connector without blocker.



Code	Version
11020710	BSPT 1/4"
11020721	BSPT 3/8"
11020722	BSPT 1/2"



Code	Version
11020810	BSPP 1/4"
11020821	BSPP 3/8"
11020822	BSPP 1/2"



Code	Version
11020921	Barb. 8 mm.
11020922	Barb. 10 mm.

Nitto range

ASIA-PACIFIC MARKET EXCLUSIVE PROFILE

Quick coupling

Nitto RANGE (2 units)
High flow. ID 7-8 mm.
Made of high-carbon steel. Anti-corrosion blue galvanized finish. Connector without blocker.



Code	Version
11021001	BSPT 1/4"
11021002	BSPT 3/8"



Code	Version
11021101	BSPP 1/4"
11021102	BSPP 3/8"



Code	Version
11021201	Barb. 8 mm.
11021202	Barb. 10 mm.

Threaded couplings

Connection coupling

(2 units)
High flow.
Made in brass. Anticorrosive treatment.

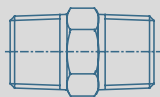

Code	Version
11000101	BSPT 1/4" M - M
11000102	BSPT 1/2" M - M
11000103	BSPT 3/8" M - M



Code	Version
11000106	BSPP 1/2" F at 3/8" M
11000107	BSPP 3/8" F at 1/4" M
11000108	BSPP 3/8" M at 1/4" F

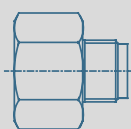

Code	Version
11000104	BSPT 1/2" M at 3/8" M
11000105	BSPT 3/8" M at 1/4" M
11000112	BSPT 1/2" M at 3/8" F
11000113	BSPT 1/2" M at 1/4" F

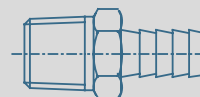

Code	Version
11000109	BSPT 1/2" M at 8 mm. barb.
11000110	BSPT 3/8" M at 8 mm. barb.
11000111	BSPT 1/4" M at 8 mm. barb.



Air hose



**Anti-static
compressed air hose**

Ideal for painting in the booth

Light, flexible and
manageable

Twist free

Anti-static EPDM rubber hose with exterior textile reinforcement. Ideal for painting in the booth.

High security crimped ends able to bear the high temperatures of the booth. No need to use flanges, avoiding that they release or cause leaks due to dilation.

Code	Version
56414014	2.5 m. 6x12 mm. F/F 1/4"
56414024	6 m. 8x15 mm. F/F 1/4"
56414025	11 m. 8x15 mm. F/F 1/4"
56414027	16 m. 8x15 mm. F/F 1/4"
56414026	26 m. 8x15 mm. F/F 1/4"

TECHNICAL DETAILS

- > Working temperature: -40°C to +120°C.
- > Working pressure: 20 bar
- > Breaking strain 80 bar
- > Anti-stick exterior
- > Internal diameter 8 mm. Valid for to be used with HVLP high flow guns
- > Meets Regulation 97/23/CE
- > 1/4" H couplings with conical closure and flare fitting for easy assembly of the push connector
- > Conducting pipe < 1 MΩ
- > Max. temperature: 120°C
- > Tough (breaking strain 80 bar)



**100 m. roll
of hose**

Multi-use hose

Meets Regulation
97/23/CE

Code
52450008

Multi-use thermo rubber hose with Polyester outer reinforcement. Compact with excellent performance and oil resistance.



TECHNICAL DETAILS

- > 8 x 15 mm. air hose in 100 metre rolls
- > Thermal cork hose with exterior polyester reinforcement
- > Working pressure: 20 bar
- > Breaking strain 60 bar
- > Working temperature: -15°C to +60°C

INDUSTRIAL PAINTING
 General applications
 General applications guns

Pressure adhesives
Classic S1 blow guns

Adhesives
Pressure

For bead application of white glues and adhesives



Code

10151401

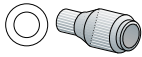

- (Ø1) SCOLAS - SG418030
- (Ø2) SCOLAS - SG418026
- (Ø3) SCOLAS - SG418027

Especially for bead applications of glues and adhesives. White glue application for the wood industry.

Teflon-coated body makes cleaning easy. Incorporates a series of 1 and 2 mm. caps and product flow regulator.

The 3 mm. aircap, scoring aircap (to mark lines) and 4-aperture aircap (to apply glue to cavities) can be acquired as options.

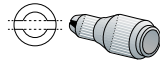

(Ran) SCOLAS - SG418029

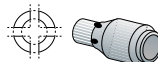

(Ø4) SCOLAS - SG418028



Classic S1

Blowgun

Made of aluminum

Light and robust

Code	Version
20340601	Metallic aircap
20340604	With extension
20340603	Plastic aircap



Three versions of the blow gun Classic S1:

- Classic S1 with metallic aircap.
- Classic S1 with extension.
- Classic S1 with plastic aircap.

Blowgun with body built in aluminum. Light but robust.

Classic S1
Metallic aircap



Classic S1
With extension

Classic S1
Plastic aircap

DATOS TÉCNICOS

- > Boquilla de plástico/metálica/alargadera
- > Peso: 187/190/198 g
- > Racor de 1/4" macho
- > Consumo de aire: 240 L/min a 6 bar de presión de aire en la entrada
- > Presión de trabajo: 3 bar - 10 bar
- > Presión máxima: 10 bar

TECHNICAL DETAILS

- > Metallic Aircap
- > Weight: 225 g
- > 1/4" male coupling
- > Air consumption: 240 L/min. at 6 (air inlet pressure)
- > Air outlet: 925 L/min. at 6 bar
- > Working pressure: 3 bar - 10 bar
- > Maximum pressure: 10 bar



Classic S1 Venturi

Blowgun made of aluminum

Venturi System

High Air flow

Code

20340605

518 Pro and 416

**518
 PRO**

Code

10330301

Total regulation on product flow and spray size

Operating pressure



Pressurized pneumatic gun for antigravel cartridges and underbody protection.

Total regulation on product flow and quality of atomization and spray size. Air inflow regulator. Operating pressure. The cartridge container is made in anodized aluminum. It is light and sturdy. Needle regulator to control precisely the texturing. Very accurate depressurizing valve. It is easy to handle even with gloves.

Special air cap for cavity wax, that includes two types of dispensers. (OPTIONAL). Stainless steel silencer.

The 518 Pro works with low pressure and offers the maximum regulation options and productivity.



TECHNICAL DETAILS

- > Empty weight: 1,369 g
- > Connection: 1/4" male coupling
- > Air consumption: 120 L/min at 3.5 bar air pressure
- > Working pressure: 2 bar - 4 bar
- > Maximum pressure: 10 bar

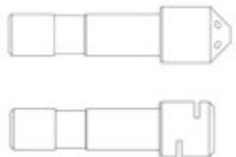

Rosette nozzle

360° Nozzle

Nozzle Kit + Spray gun adapter

Code

56418705

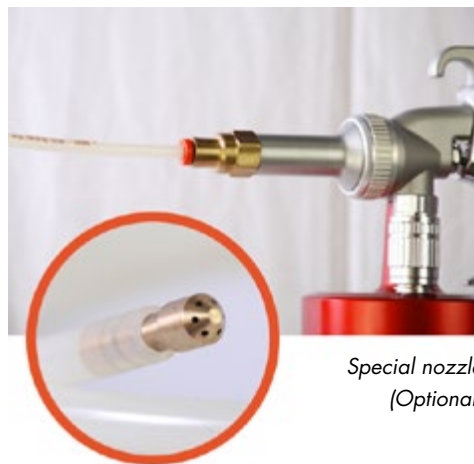

Special nozzle (Optional)

416

Screwed directly to the cartridge

Operation by suction

Adjustable metallic aircap

Pneumatic gun for antigravel cartridges and underbody protection. Operation by suction.

Gun for the application of standardized acoustic insulation 1 L. cartridges. To be screwed directly to the cartridge. Adjustable metallic aircap to control the quantity and texture of the product.

TECHNICAL DETAILS

- > Empty weight: 520 g
- > Connection: 1/4" male coupling
- > Air consumption: 160 L/min at 3.5 bar air pressure
- > Working pressure: 3 bar - 10 bar
- > Maximum pressure: 10 bar

Code

20330401



INDUSTRIAL PAINTING
 General applications
 Pneumatic
 sealer gun

**3900 Plus and
 3900 Plus M4/6 sealers**



**3900
 PLUS M6**



**3900
 PLUS M4**



**3900
 PLUS**

Sturdy aluminum body

Quick Closing

Metal air distributor

Discharge valve

1/4" Standard Connection

The new 3900 Plus pneumatic sealers are a compact, efficient and light solution for everyday needs in any workshop. These pneumatic guns are very useful when it comes to structure assembling, repairs and windshield set-ups, amongst others.

There are two versions: the 3900 Plus for sealants in cartridges and the 3900 Plus M for sealants in sausages. Both versions include a trigger with discharge valve, which guarantees a great precision and control.

The metallic internal parts assure a long working life. Besides, those parts do not require any manipulation neither any maintenance.

Its body is made of high resistance aluminum. The front part on the 3900 Plus is made of non-deformable plastic.

The 3900 Plus sealers are a very strong product capable to work for long working hours.

3900 Plus

Code

10330201

3900 Plus M4

Code

10330401

3900 Plus M6

Code

10330402

TECHNICAL DETAILS 3900 PLUS - CARTRIDGE

- > Front part made in plastic.
- > Bead application of sealers and silicone in 300 ml. cartridges.
- > 1/4" Air inlet
- > Weight: 540 g / Length: 250 mm
- > Working pressure: 4 - 6 bar
- > Discharge valve to shut-off the product outlet when releasing the trigger.

TECHNICAL DETAILS 3900 PLUS M - SAUSAGE

- > Front part made in anodized aluminum.
- > Bead application of sealers and silicone in sausage:
 - 300 & 400 ml. **3900 PLUS M4**
 - 600 ml. **3900 PLUS M6**
- > 1/4" Air inlet
- > **3900 PLUS M4:** Weight: 560 g / Length: 250 mm
- > **3900 PLUS M6:** Weight: 570 g / Length: 320 mm
- > Working pressure: 4 - 6 bar
- > Discharge valve to shut-off the product outlet when releasing the trigger.



Profiled composite casing:
comfortable and long-lasting

High performance sanders
Extremely high finish quality
Light, compact and powerful
No surface contamination

L505

Sander designed for grinding and fast sanding

L252

Sander for high quality finishes

Code L505

40000232

Code L252

40000231

L252R

Sander for fine finishes

Code

40000230



The air outlet is spins 360°

The air can be oriented and kept away from the use

Fitted for extraction, it is easily connected to central or portable extraction systems

"L" range sanders

"L" range sanders have been designed for workshops where high performance and top quality finishes are demanded. If you are looking for scratch-free quality, you can trust the "L" range. Due to the lubricant-free design, there is no concern about substrate contamination.

0.2 HP motor, 12,000 r.p.m.

The L505 is a pneumatic orbital sander with a 5 mm. oscillation designed for quick grinding down, with a good quality surface finish.

The L252 is a pneumatic orbital sander with an oscillation of 2.5 mm. which ensures high quality finishes without leaving any kind of marks on the surface.

TECHNICAL DETAILS

- > Plate size: 152 mm./6 inch
- > Oscilation L505: 5 mm. L252: 2.5 mm.
- > Free speed: 12,000 r.p.m.
- > Net weight: 0.87 Kg.
- > Total length: 118 mm.
- > Air consumption: 220 L/min.
- > Air inlet: 1/4"
- > Min. size hose: 8 mm.

The L252R is a pneumatic orbital sander which ensures precision sanding and top quality finishing. It is ergonomic and light, perfect for those small retouches.

TECHNICAL DETAILS

- > Plate size: 75 mm./3 inch
- > Oscilation L252R: 2.5 mm.
- > Free speed: 12,000 r.p.m.
- > Net weight: 0.84 Kg.
- > Total length: 110 mm.
- > Air consumption: 220 L/min.
- > Air inlet: 1/4"
- > Min. size hose: 8 mm.

Sand disks

Code	Version
49000220	75 mm. ø sand disk (Velcro) L252R
49000501	152 mm. ø sand disk (Multiholes, Velcro) L252, L505

Catalogue 2020

INDUSTRIAL PAINTING

Sanding systems

Pneumatic sanders



Composite impellers and rotor Lubrication-free, works without oil. Counterweight system to guarantee smooth operation.



INDUSTRIAL PAINTING

Personal protection

Máscaras de respiración

Equipo de respiración 4240 y máscara MP 300



Face Mask 4240

Full breathing equipment

Maximum protection

Code	Version
15830101	US-Mil
15830102	Nitto

Does not include hose kit

Code	Version
15830103	US-Mil*
15830104	Nitto*

*Hose kit included: 10 meters of hose and safety plugs, 1,5 meter of hose spray gun outlet.

Complete breathing equipment which includes: belt, pocket regulator and coalescent filter to remove low levels of moisture and oil. 10 meters of hose and safety plugs, 1,5 meter of hose spray gun outlet.

Preset regulator incorporating flow warning gauge with integrated high efficiency coalescent filter. Carbon filter to absorb vapour and odour.

The unit conforms to BS EN 1835, with a protection factor of 40. EC Certificate Number 58459, issued by BSi Product Certification.

89/686/CEE (EPI) approved.

Spares face mask

Code	Version
15880013	SPARE visor 10 units
15880015	Carbon FILTER
15880011	Acetate screen KIT



Hose kit

MP300

Mask with double charcoal filter against organic and solvent fumes

Facial housing of thermoplastic rubber

Elastic tape fastener

Double air inlet, allowing higher flow inhalations, making easier to breathe. Antiallergic. The mask is fitted with two carbon filters and a exhaling valve.

Suitable to be used in atmospheres contaminated with fumes and vapours with a boiling point over 65°C, like solvents and paints, offering a proper protection (with oxygen content in the air over 17% in volume).

Each of the built-in chemical filters of the mask is classified as "filter against fumes, A type, class 1" according to EN 141, and are also certificated separately.

Approved
EN 140:1998
EN 143:2000/A1:2006
EN 14387:2004+A1:2008
Regulatory agency: No.00082

Code
14810301

SPARE Paint filter against organic and solvent fumes. 10 units.

Code
56418052

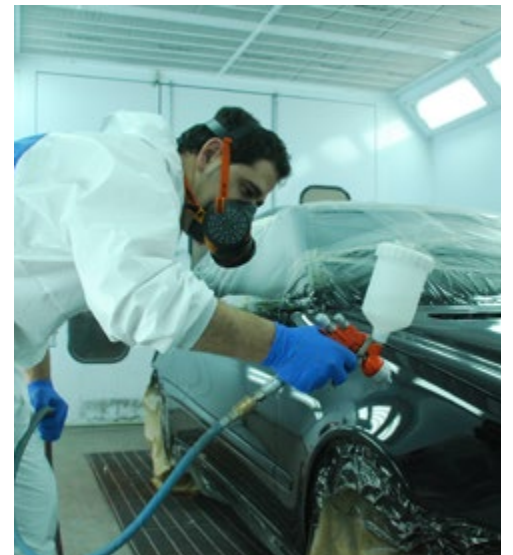



FFP2 masks, MP2 mask and Antistatic Coverall



M210 Model



M200 Model

Masks FFP2

Self-filtering paper masks

Code	Version
40000263	M200
40000264	M210 with valve

For solid and liquid particles of low and medium toxicity. For use against non-ferrous metal dust, welding metal fumes, gasses and mists NOT INCLUDING materials such as lead, aluminium and manganese.

Double elastic tape. Flexible metallic strip for adjustment to nose, area.

NPF (nominal protection factor): 12 (concentration permitted in the atmosphere 12 times the TLV)

TECHNICAL DETAILS

M200 Model

> Comes in a 20-unit box.

M210 Model

> Comes in a 10-unit box.

> Built-in exhalation valve to make breathing easier.

Classic MP2

Mask with double charcoal filter against organic and solvent fumes

Facial housing of thermoplastic rubber

Elastic tape fastener

Code
14810201

Double air inlet, allowing higher flow inhalations, for easier breathing.

Each of the built-in chemical filters of the mask is classified as "filter against fumes, A type, class 1" according to EN 141, and are also certificated separately.

79mm diameter cylinder shape filter.



Approved
EN 140:1998
EN 141:2000
UE 2016/425
Regulatory agency: No.00082

TECHNICAL DETAILS

> Breathing resistance:

To air Flow 25 x 2 L/min

To inhalation: 0.52 mbar

To exhalation: 1.64 mbar

> To continuous flow inhalation:

30 L/min flow: 0.11 mbar

95 L/min flow: 0.33 mbar

> CO2 content (death space): 0.60%

> Escapes to the interior (hermeticity): < 2

SPARE Paint filter against organic and solvent fumes. 10 units.

Code
56418052

Antistatic Coverall

Air ventilation system

Breathable

Water repellent and dirt-resistant

Code	Size	EU size
40000523	XS	38/40
40000524	S	42/44
40000525	M	46/48
40000526	L	50/52
40000527	XL	54/56
40000528	2XL	58/60
40000529	3XL	62/64

Breathable panel in the back and underarms.

Adjustable hood with elastic band and velcro. Press-buttons neck closure. Elastic ankle and wr

2-way zip and flap fitted with 2 breast pockets, inside pocket, 2 side pockets and a hip pocket.

Original Dupont Teflon coating (water repellent and dirt-resistant).

Silicone and lint free.

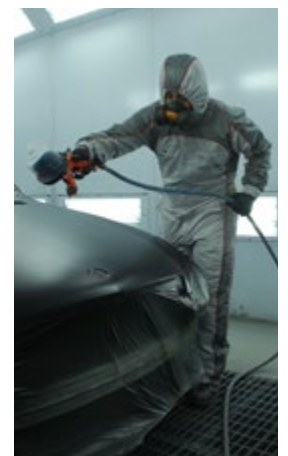

TECHNICAL DETAILS

> Material: 98% polyester, 2% carbon

> Standard EN1149: 1 Permanent antistatic

> PPE CAT. I

> Washable at 30°C or by chemical cleaning

Can and carton crusher

Can Crusher

Simple, versatile and efficient

Code

40000314

Meets European Directive 98/37/CEE of 22 January 1998.

Significant space saving and cost reduction in waste management.



Designed to solve residue storage and disposal problems in places like bodyshops, industrial workshops, garages, etc.

Can Crusher

Greater load. Valid for cylindrical recipients up to 25 L.

TECHNICAL DETAILS

- > Dimensions: 510 x 540 x 1,460 mm
- > Working pressure: 8 bar
- > Power: above 1,700 Kg
- > Pneumatic safety system
- > Total weight: 185 Kg

Can and carton crusher

Functional and complete

Code

40000315

Meets European Directive 98/37/CEE of 22 January 1998.

Significant space saving and cost reduction in waste management.

Designed to solve residue storage and disposal problems in places like bodyshops, industrial workshops, garages, etc.



Two accesses:

- > Upper: loads cardboard and paper.
- > Lower: unloads cardboard, loads cans.

Reel of string at rear to tie the crushed bundles of paper and cardboard.

TECHNICAL DETAILS

- > Dimensions: 560 x 750 x 1,750 mm
- > Working pressure: 8 - 9 bar
- > Pneumatic safety system
- > Total weight: 225 Kg

Industrial and construction application guides, aircaps, nozzles and spray gun and pump accessories

Service, a key word in SAGOLA's
strategic approach to bodyshop.

One of our main concerns is to make the painter
be able to quickly identify and acquire the main
SAGOLA original spare parts - nozzles, needles,
aircaps, racks, deposits, regulators...

In this section we offer our application guides
and our main complements.

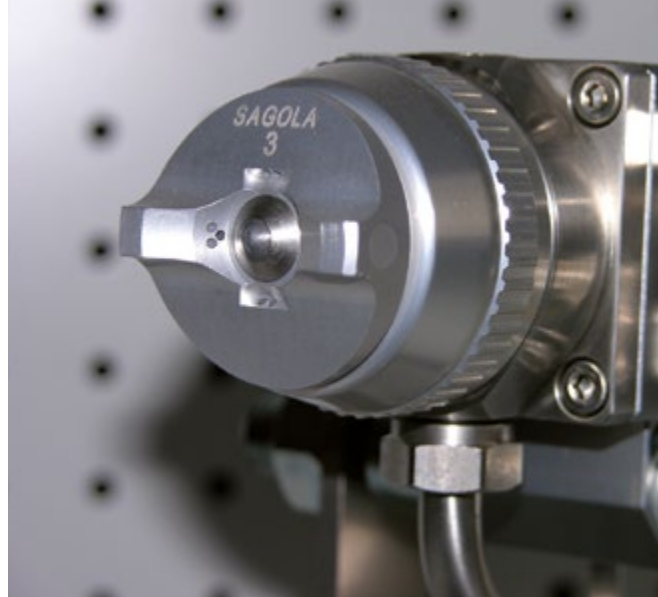

Extensions for spray guns

Extension for 4100 Xtreme

Versions extension for 4100 Xtreme spray gun.
150, 300 and 500 mm. extensions for a variety of needles.

Code	Name
52411721	Extension 150 mm. 1.00 Serie 4100
52411722	Extension 150 mm. 1.20 Serie 4100
52411723	Extension 150 mm. 1.40 Serie 4100
52411724	Extension 300 mm. 1.00 Serie 4100
52411725	Extension 300 mm. 1.20 Serie 4100
52411726	Extension 300 mm. 1.40 Serie 4100
52411727	Extension 500 mm. 1.20 Serie 4100
52411732	Extension 500 mm. 1.80 Serie 4100

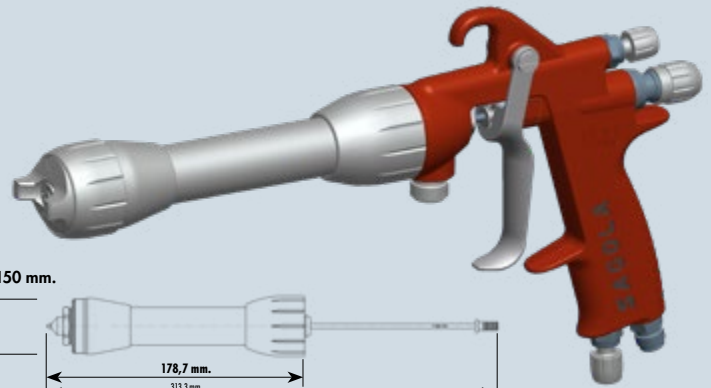

Extension 150 mm.

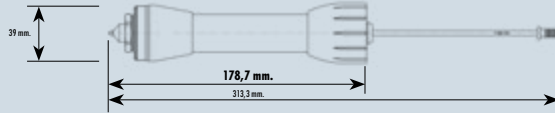

Extension 300 mm.

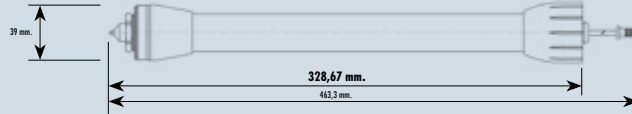

Extension 500 mm.

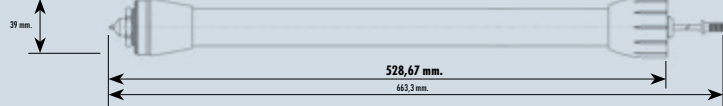

Extension for MiniXtreme

Versions extension for Mini Xtreme spray gun.
150 and 300 mm. extensions for a variety of needles.

Code	Name
52411713	Extension 150 mm. 0.80 MiniXtreme
52411714	Extension 150 mm. 1.00 MiniXtreme
52411715	Extension 150 mm. 1.20 MiniXtreme
52411716	Extension 150 mm. 1.40 MiniXtreme
52411717	Extension 300 mm. 0.80 MiniXtreme
52411718	Extension 300 mm. 1.00 MiniXtreme
52411719	Extension 300 mm. 1.20 MiniXtreme
52411720	Extension 300 mm. 1.40 MiniXtreme

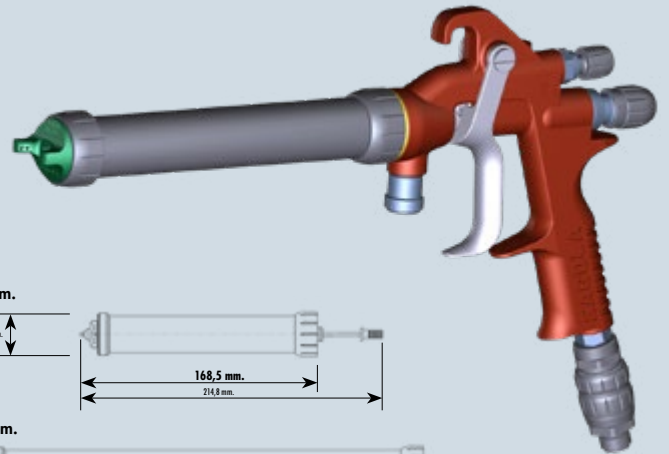

Extension 150 mm.

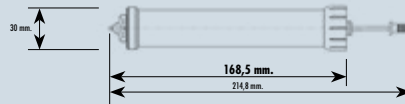

Extension 300 mm.

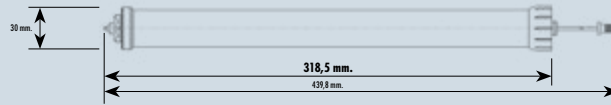

Extension for Mini V

Versions extension for Mini V automatic spray gun.
300 mm. extensions for a variety of needles.

Code	Name
52411730	Extension 300 mm. 1.20 Mini V
52411731	Extension 300 mm. 1.30 Mini V

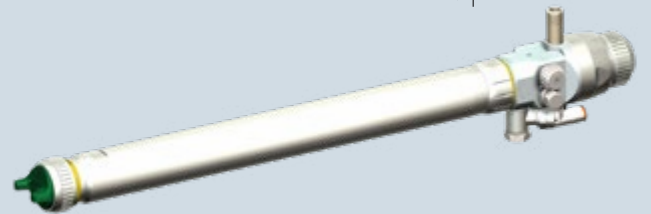

Extension 300 mm.

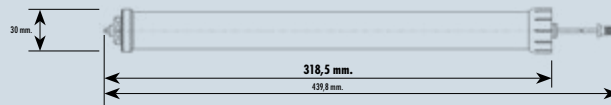

Lateral jet aircap

Mini V series.

Code
56411117



Lateral jet aircap

4100 Xtreme series.

Code
56418621





Spray Gun Accessories

Air flow regulators



Code
56418020

Flow regulator with pressure gauge RC1

Aluminium, very light. Ideal for high transfer HVLP and EPA spray guns Red-to-green pressure scale (green within provisions of regulations). Assembled in seconds with hermetic hand tightening.



Code
56418519

High precision flow regulator

High precision air-flow regulator kit. Solvent-proof gaskets. Suitable for 4600 Xtreme digital. Recommended for finishing spray guns.



Code
40000335

Flow regulator RC2

Pressure gauge flow regulator. Exact input pressure gun. High quality gauge green scale for high transfer guns.

Ford 4 viscosimeter

Code
56418001

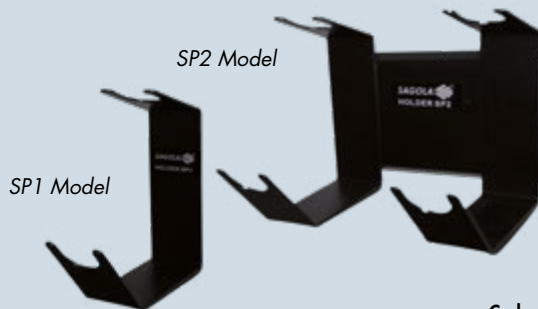

Magnetic Stands SP1 and SP2

Magnetic stand for 1 (SP1) or 2 (SP2) spray guns. Solvent-proof paint. Supports PPS type adapters. Maximum robustness. High holding power due to two powerful magnets.

Code	Version
40000245	SP1
40000246	SP2



Pressurizer kit

for gravity spray guns. Gravity cup pressure kit for high viscosity materials spraying. Non-return valve included.

Code
56418513

Accessories for cleaning and maintenance



Cleaning kit

Complete cleaning set, including one brush for outside cleaning, and rods of different sizes for all the inner paths of the spray gun. Supplied in a practical show case.

Code
40000086



Lubricant grease

Natural grease, specially made for spray guns and painting equipments moving parts lubrication. High consistency, even under extreme temperatures. Long lasting, it doesn't lose properties over the time. Easy to open 100 ml. can.

Code
56418589

Gravity deposits

High quality deposits for gravity spray guns.

Code	Name	Spray Gun Range
56418432	0.65 L. Gravity Deposit Kit	4600 Xtreme/4500 Xtreme
56418084	0.65 L. Gravity Deposit Kit	4100 Xtreme/3300 GTO-PRO/Classic PRO XD
56418085	0.65 L. Gravity Deposit Kit - without filter	4100 Xtreme/3300 GTO-PRO/Classic PRO XD
56418420	0.65 L. Gravity Deposit Kit	Classic LUX Gravity
56418080	0.50 L. Gravity Deposit Kit	Mini Xtreme Gravity
49000430	0.60 L. Gravity Deposit Kit	Junior G
56418081	0.125 L. Gravity Deposit Kit	Mini Xtreme Gravity/475 XTECH
56418079	0.200 L. Gravity Deposit Kit	Mini Xtreme Gravity/475 XTECH
56418431	0.120 L. Gravity Deposit Kit	474
56418099	0.125 L. Gravity Deposit Kit	Special Ultra Violet
56418505	1 L. Gravity Deposit Kit	4600 Xtreme/4500 Xtreme/4100 GTO
56418082	1 L. Metallic Gravity Deposit Kit	4100 Xtreme/3300 GTO-PRO



Product filter kit

Product filter kit for gravity spray guns.

Code	Name	Spray Gun Range
56418017	10 Product Filter Kit (Gravity) 0.65 L	4100 Xtreme/3300 GTO-PRO/Classic PRO XD
56418438	10 Product Mini-Filter Kit (Gravity)	4600 Xtreme/4500 Xtreme/4100 GTO
56418059	10 Product Filter Kit (Gravity) 0.50 L	Mini Xtreme Gravity
56418061	6 Product Filter Kit (Gravity) 0.125 L	Mini Xtreme Gravity
56418479	5 Product Filter Kit (Gravity)	474



Couplings

for disposable deposits

Code	Name	Spray Gun Range
55711612	Couplings 3M PPS	4100/3300 GTO/3300 PRO/Mini XTREME
55711616	Couplings MIPA / CARWOX	4100/3300 GTO/3300 PRO/Mini XTREME
55711614	Couplings GERSON / NORTON	4100/3300 GTO/3300 PRO/Mini XTREME
55711615	Couplings FLEXI CUP	4100/3300 GTO/3300 PRO/Mini XTREME
55711618	Couplings Devilbiss / DEKUPS	4100/3300 GTO/3300 PRO/Mini XTREME
55711620	Couplings SATA RPS	4100/3300 GTO/3300 PRO/Mini XTREME
55711623	Couplings COLAD	4100/3300 GTO/3300 PRO/Mini XTREME



Suction Deposit, gaskets and filters

Code	Name	Spray Gun Range
56418074	Suction Deposit Kit 1.00 L	4100 Xtreme/Classic PRO XD/Classic LUX
56418076	Suction Deposit Kit 0.5 L. (403/435)	403/435
56418014	10 Product Filter Kit (Suction)	4100 Xtreme/Classic PRO XD/Classic LUX
56418013	5 Suction Spray Gun Anti-drip Lid Kit	4100 Xtreme/Classic PRO XD/Classic LUX
56418509	Deposit Closure Flanged Washer	4100 Xtreme/Classic PRO XD/Classic LUX



Other kits and accessories

Air valve, paint packing, joints,...

Code	Name	Spray Gun Range
56418445	Air Valve Kit	Línea XTREME
56418514	Air Valve Kit	Mini XTREME
56418481	Air Valve Kit	4100 GTO/3300 GTO-PRO/Classic PRO/Classic LUX
56411616	Paint Packing Nut	4600 Xtreme/4500 Xtreme/4300/4100
56418034	Paint Packing Nut. Needle + Product	Mini Xtreme
56418441	Air Gasket Replacement Kit (6 units)	4600 Xtreme/4500 Xtreme/Mini Xtreme
56418494	Air Gasket Replacement Kit (6 units)	4100 GTO/3300 GTO-PRO/Classic PRO/Classic LUX
49000422	Air Valve Kit	Junior G
49000425	Paint Packing Nut	Junior G
56418449	Air Valve Kit	474
56418452	Paint Packing Nut	474
56418703	Close Gasket Replacement Kit	518 PRO



Spray Gun Aircaps

The **aircap model** is vital to achieve the desired results. The type of product we are going to apply and the application system we are going to use must both be taken into account when selecting an aircap. Correctly combining the aircap with the adequate nozzle and needle kit, the desired spray quality will be obtained.

High transfer aircaps

Code	Aircap	Spray gun model	System Transfer	Application	Nozzle+ Needle mm.	Air consumption L/min. (2 bar)	Flow gr/min.	Fan pattern average mm.
56418565	XTO1	4100 G/4100 Xtreme G 4100 Xtreme Suction	EPA 65%	Maximum performance, Clearcoats, Basecoats and metallized	1.3 - 1.8	280	180	290
56418564	XTO1 B	4100 Xtreme Pressure	EPA 65%	High gloss pressure finishes	0.8 - 1.4	380	250	300
56418566	XTO3	4100 G/4100 Xtreme G 4100 Xtreme Pressure	HVLP 75%	Maximum atomisation quality and minimum mist. 0.7 bar at aircap	0.8 - 1.6	460	180	310
56418572	3030	4100 G 4100 Xtreme Pressure	HVLP 75%	Finishes and primers. Maximum mist reduction. 0.7 bar at aircap	1.2 - 2.2	420	280	300
56418524	MINI AQUA	Mini Xtreme	EPA 65%	Special Spot Repair, painting of parts. Basecoats, clearcoats and waterborne paints	0.8 - 1.2	190	110	230
56418525	MINI EPA	Mini Xtreme Gravity Mini Xtreme Pressure	EPA 65%	Finishes: maximum quality spray with significant saving of material.	0.8 - 1.4	200	155	260
56418526	MINI HVLP	Mini Xtreme Gravity Mini Xtreme Pressure	HVLP 75%	Maximum transfer, great saving of material with minimum air consumption.	0.8 - 1.4	310	150	250
56418560	MINI VIT	Mini Xtreme Pressure	EPA 65%	High speed application. Wide fan patterns.	0.8 - 1.4	350	250	310
56418558	GTO EVO	3300 GTO	EPA 65%	High gloss finishes, basecoats.	1.3 - 1.6	320	175	280
56418645	GTO EPA	3300 GTO	EPA 65%	Finishes and primers. Minimum air consumption.	1.4 - 1.8	240	160	250
56418552	GTO HVLP	3300 GTO	HVLP 72%	Finishes and fillers. Minimum mist, maximum savings. 0.7 bar at aircap.	1.4 - 1.8	360	130	300
56418639	21 EPA	CLASSIC PRO XD	EPA 65%	Fillers, Primers. Maximum performance	1.4 - 1.8	210	1392	250
56418643	HVLP	CLASSIC PRO XD	HVLP 72%	Fillers, Primers. Minimum mist, maximum saving. 0,7 bar at aircap	1.4 - 1.8	355	189	280

Conventional Spray Aircaps

Code	Aircap	Spray gun model	System Transfer	Application	Nozzle+ Needle mm.	Air consumption L/min. (2 bar)	Flow gr/min.	Fan pattern average mm.
56418573	96	4100G, 4100 Xtreme Suc.	Medium Pressure 55%	Finishes: high quality, high speed.	1.3 - 1.8	350	220	320
56418575	64 S	4100G, 4100 Xtreme Suc.	Medium Pressure 55%	Waterborne clearcoats and clears. High micronage. Glues, adhesives.	2.2 - 2.5	310	310	290
56418574	62 S	4100 G	Medium Pressure 55%	High viscosity. Polyester for spray guns, cast iron effect. Enamels, ceramics.	2.8	340	400	280
56418571	765	4100 Xtreme Pressure	Medium Pressure 55%	Pressure finishes. Wide fan patterns.	1.0 - 1.8	410	280	365
56418576	777	4100 Xtreme Pressure	Medium Pressure 55%	Maximum atomising power, high gloss finishes. Basecoats.	0.8 - 1.4	420	300	400
56418568	67	4100 Xtreme Pressure	Medium Pressure 55%	Ceramic products, silicates, abrasives.	1.8CT	400	300	290
56418570	64	4100 Xtreme Pressure	Medium Pressure 55%	High micronage, large nozzles.	2.2-2.5	390		280
56418567	62	4100 Xtreme Pressure	Medium Pressure 55%	High viscosity products.	2.8	410		260
56418569	20	4100 Xtreme Pressure	Medium Pressure 55%	Glues, adhesives.	1.2-1.8	430	300	360
56418640	25	Classic Pro XD	Conv. 50%	Thick primers	2.0	260	200	300
56418642	36	Classic Pro XD	Conv. 50%	Intermediate coats, thick products, glues.	2.5	320	300	285
56418641	28	Classic Pro XD	Conv. 50%	High viscosity, gun-applied mastics, cast iron effect.	2.8	320	350	260
56418246	0,5	475 XTech	Conv. 50%	Feathering	0.5 - 0.8	100	60	125
56418247	1.0	475 XTech	Conv. 50%	Parts coating, retouches.	1.0	110	90	180
56418271	R5	475 XTech	Conv. 50%	High precision round pattern. Feathering and fine sign-writing.	0.5 R	45		15-100



Nozzle + Needle Kit

Code	Name	Spray Gun Range	Code	Name	Spray Gun Range	
10011251	Nozzle+needle kit 0.8 - 41 series	4100 XTREME GRAVITY	10011187	Nozzle+needle kit 1.40	CLASSIC PRO XD	
10011252	Nozzle+needle kit 1.0 - 41 series		10011180	Nozzle+needle kit 1.60		
10011253	Nozzle+needle kit 1.2 - 41 series		10011191	Nozzle+needle kit 1.80		
10011121	Nozzle+needle kit 1.3 - 41 series		10011181	Nozzle+needle kit 2.00		
10011122	Nozzle+needle kit 1.4 - 41 series		10011182	Nozzle+needle kit 2.20		
10011123	Nozzle+needle kit 1.6 - 41 series		10011183	Nozzle+needle kit 2.50		
10011124	Nozzle+needle kit 1.8 - 41 series		10011188	Nozzle+needle kit 2.80		
10011125	Nozzle+needle kit 2.0 - 41 series					
10011126	Nozzle+needle kit 2.2 - 41 series					
10011127	Nozzle+needle kit 2.5 - 41 series					
10011128	Nozzle+needle kit 2.8 - 41 series					
10010129	Nozzle+needle kit 1.2 CT - 41 series	4100 XTREME GRAVITY	10011198	Nozzle+needle kit 1.0	475 XTECH	
10010130	Nozzle+needle kit 1.4 CT - 41 series		10011197	Nozzle+needle kit 0.8		
10010131	Nozzle+needle kit 1.5 CT - 41 series		10011195	Nozzle+needle kit 0.5		
10010132	Nozzle+needle kit 1.8 CT - 41 series		10011196	Nozzle+needle kit 0.5 CHR		
10010133	Nozzle+needle kit 2.2 CT - 41 series					
10010134	Nozzle+needle kit 2.8 CT - 41 series					
10011100	Nozzle+needle kit 0.8 - 40 series	4100 XTREME SUCTION 4100 4200 4300	1001221	Nozzle+needle kit 0.8 - 450A	450 A 4200 A	
10011101	Nozzle+needle kit 1.0 - 40 series		1001222	Nozzle+needle kit 1.0 - 450A		
10011102	Nozzle+needle kit 1.2 - 40 series		1001223	Nozzle+needle kit 1.2 - 450A		
10011103	Nozzle+needle kit 1.3 - 40 series		1001224	Nozzle+needle kit 1.4 - 450A		
10011104	Nozzle+needle kit 1.4 - 40 series		1001226	Nozzle+needle kit 1.8 - 450A		
10011106	Nozzle+needle kit 1.6 - 40 series		1001230	Nozzle+needle kit 2.0 - 450A		
10011107	Nozzle+needle kit 1.8 - 40 series		10010156	Nozzle+needle kit 1.2 CT - 450A		
10011119	Nozzle+needle kit 2.0 - 40 series		10010157	Nozzle+needle kit 1.4 CT - 450A		
10011108	Nozzle+needle kit 2.2 - 40 series		10010158	Nozzle+needle kit 1.5 CT - 450A		
10011109	Nozzle+needle kit 2.5 - 40 series		10010159	Nozzle+needle kit 1.8 CT - 450A		
10011120	Nozzle+needle kit 2.8 - 40 series		10010160	Nozzle+needle kit 2.2 CT - 450A		
			10010161	Nozzle+needle kit 2.8 CT - 450A		
10010145	Nozzle+needle kit 1.2 CT - 40 series	4100 XTREME SUCTION 4100 4200 4300	1001207	Nozzle+needle kit 0.8 - 4041	4041	
10010146	Nozzle+needle kit 1.4 CT - 40 series		1001208	Nozzle+needle kit 1.0 - 4041		
10010147	Nozzle+needle kit 1.5 CT - 40 series		1001209	Nozzle+needle kit 1.2 - 4041		
10010148	Nozzle+needle kit 1.8 CT - 40 series		1001210	Nozzle+needle kit 1.4 - 4041		
10010149	Nozzle+needle kit 2.2 CT - 40 series		1001211	Nozzle+needle kit 1.6 - 4041		
10010150	Nozzle+needle kit 2.8 CT - 40 series		1001212	Nozzle+needle kit 1.8 - 4041		
			10010123	Nozzle+needle kit 1.2 CT 4041		
			10010124	Nozzle+needle kit 1.4 CT - 4041		
		10010125	Nozzle+needle kit 1.5 CT - 4041			
		10010126	Nozzle+needle kit 1.8 CT - 4041			
		10010127	Nozzle+needle kit 2.2 CT - 4041			
		10010128	Nozzle+needle kit 2.8 CT 4041			
10011200	Nozzle+needle kit 0.8 Mini series	Mini XTREME 403	56418150	Nozzle+needle kit 0.8 - V series	V4 V5 V6	
10011201	Nozzle+needle kit 1.0 Mini series		56418151	Nozzle+needle kit 1.0 - V series		
10011202	Nozzle+needle kit 1.2 Mini series		56418152	Nozzle+needle kit 1.2 - V series		
10011203	Nozzle+needle kit 1.3 Mini series		56418153	Nozzle+needle kit 1.4 - V series		
10011204	Nozzle+needle kit 1.4 Mini series		56418154	Nozzle+needle kit 1.8 - V series		
10011205	Nozzle+needle kit 1.6 Mini series		56418101	Nozzle+needle kit 1.2 CT - V series		
10011206	Nozzle+needle kit 1.8 Mini series		56418102	Nozzle+needle kit 1.4 CT - V series		
			56418103	Nozzle+needle kit 1.8 CT - V series		
		56418104	Nozzle+needle kit 2.2 CT - V series			
		56418105	Nozzle+needle kit 2.8 CT - V series			
10011187	Nozzle+needle kit 1.0 - 3300 series	3300 GTO 3300 PRO 3200				
10011180	Nozzle+needle kit 1.2 - 3300 series					
10011191	Nozzle+needle kit 1.3 - 3300 series					
10011181	Nozzle+needle kit 1.4 - 3300 series					
10011182	Nozzle+needle kit 1.6 - 3300 series					
10011183	Nozzle+needle kit 1.8 - 3300 series					
10011188	Nozzle+needle kit 2.0 - 3300 series					
10011192	Nozzle+needle kit 2.2 - 3300 series					
10011189	Nozzle+needle kit 2.5 - 3300 series					
10011190	Nozzle+needle kit 2.8 - 3300 series					
10011370	Nozzle+needle kit + aircap 1.6	CLASSIC LUX GRAVITY				
10011371	Nozzle+needle kit + aircap 1.8					
10011372	Nozzle+needle kit + aircap 2.0					
10011373	Nozzle+needle kit + aircap 2.5					
10011374	Nozzle+needle kit + aircap 1.6	CLASSIC LUX SUCTION				
10011375	Nozzle+needle kit + aircap 1.8					

Nozzle + Needle Kit

Code	Name	Spray Gun Range
10011374	Nozzle+needle kit + aircap 1.60	CLASSIC LUX SUCTION
10011375	Nozzle+needle kit + aircap 1.80	
20010148	Nozzle+needle kit 2.00 Classic Smooth	CLASSIC SMOOTH
20010149	Nozzle+needle kit 2.50 Classic Smooth	
20010145	Nozzle+needle kit 1.40 Classic Pressure	CLASSIC LUX PRESSURE
20010147	Nozzle+needle kit 1.80 Classic Pressure	
10011231	Nozzle+needle kit 1.00 455 HVLP	455 HVLP
10011232	Nozzle+needle kit 1.20 455 HVLP	
10011233	Nozzle+needle kit 1.40 455 HVLP	
10011234	Nozzle+needle kit 1.80 455 HVLP	
10011236	Nozzle+needle kit 2.20 455 HVLP	
10011376	Nozzle+needle kit 0.80 - 474	
10011377	Nozzle+needle kit 1.00 - 474	
20010112	Nozzle+needle kit 2.20 - 4001	4001
20010113	Nozzle+needle kit 2.80 - 4001	
20010114	Nozzle+needle kit 3.20 - 4001	
20010115	Nozzle+needle kit 4.0 - 4001	
10011378	Nozzle+needle kit 2.80 - 4022	4022
10011379	Nozzle+needle kit 3.20 - 4022	
49000431	Nozzle+needle kit 1.4	JUNIOR G
49000432	Nozzle+needle kit 1.6	
49000433	Nozzle+needle kit 1.8	

**Nozzle and Needle fitting Kit**

High pressure spray guns.
MIX/AIRLESS

Code	Name	Spray Gun Range
10011250	Nozzle and Needle fitting Kit + Joints	MINI XTREME MIX
30010013	Nozzle and Needle fitting Kit + Joint	PSAM 107 / PSAA 108
56418230	Nozzle and Needle fitting Kit	PSAM 104
56418406	Nozzle fitting Kit + Needle head	V7 AUTOMATIC
56418405	Nozzle fitting Kit + Needle head	4041 MIX



APPLICATION GUIDE

INDUSTRIAL GUNS - GRAVITY

	MODELS	4100 Xtreme Gravity			
		AIRCAPS	4100 Xtreme G Medium Pressure	4100 Xtreme G EPA	4100 Xtreme G HVLP
		Transfer/System	55% Medium Pressure	65 % EPA	75 % HVLP
GRAVITY	INDUSTRIAL BODYSHOP	Fillers	1.6-1.8 (96)	1.6 - 1.8 (XT01)	1.6-1.8 (XT03)
		Basecoats		1.3-1.4 (XT01)	1.4 (XT03)
		Clearcoats	1.4-1.6 (96)	1.4 (XT01)	
		Single stage paints and HS	1.6 (96)	1.4-1.6 (XT01)	
	METAL INDUSTRY	Primers	1.6-1.8 (96)		1.8 (XT03)
		Paints and Clears	1.4-1.6 (96)	1.4-1.6 (XT01)	
		Thick coats			2.2-2.8 (64AS-62AS)
		Silicates and abrasives	2.2 CT - 2.8 CT (64AS y 62AS)		1.8CT-2.5CT (3030)
	WOOD INDUSTRY	Dyes	1.2-1.3 (96)	1.2-1.3 (XT01)	1.3 (XT03)
		Basecoats and sealants	1.6-1.8 (96)	1.6 (XT01)	1.8 (XT03)
		Clearcoats	1.4-1.6 (96)	1.4-1.6 (XT01)	
		Pigmented clearcoats	1.4 (96)	1.4 (96)	
GENERAL INDUSTRY	Adhesives	1.8-2.5 (20)			
	Ceramics and abrasives	1.8 CT - 2.8 CT (64AS y 62AS)		1.6-2.2CT (3030)	
	Paints for Plastic and Sofw	1.4-1.8 (96)	1.4-1.6 (XT01)	1.4-1.6 (XT03)	
	Calorific	1.4-1.6 (96)	1.4-1.6 (XT01)	1.4 (XT03)	

APPLICATION GUIDE

INDUSTRIAL GUNS - PRESSURE, SUCTION



	MODELS	4100 Xtreme B			Medium Pressure	
		AIRCAPS	4100 B Medium Pressure	4100 B EPA	4100 B HVLP	55% Medium Pressure
		Transfer/System	55% Medium Pressure	65 % EPA	75 % HVLP	55% Medium Pressure
PRESSURE / SUCTION	Fillers	1.2-1.4 (765)	1.2-1.4 (XT01B)	1.2-1.4 (XT03B)	1.8 (96)	
		0.8-1.0 (777)	0.8-1.0 (XT01B)	0.8-1.0 (XT03B)	1.4 (96)	
		1.0 - 1.2 (777)	1.0-1.2 (XT01B)		1.6 (96)	
		1.2-1.4 (765)	1.2 (XT01B)			
	Primers	1.4-1.8 (765)	1.4 - 1.6 (XT01B)	1.4-1.6 (XT03B)	1.8 (96)	
		1.2 - 1.4 (765)	1.2-1.4 (XT01B)		1.6 (96)	
		2.2-2.5 (64A)				
		1.8CT-2.8CT (67A-62A)				
	Dyes	0.8-1.0 (765)	0.8-1.0 (XT01B)	0.8-1.0 (XT03B)	1.4 (96)	
		1.2-1.4 (765)	1.2-1.4 (XT01B)	1.2-1.4 (XT03B)	1.6 (96)	
		1.0-1.2 (765)	1.0-1.2 (XT01B)	1.2-1.4 (XT03B)	1.6 (96)	
		1.0-1.2 (777)	1.0-1.2 (XT01B)			
	Adhesives	1.2-1.8 (20A)				
		1.4CT-2.5CT (67A-64A)		1.4CT-2.5CT (3030)		
		1.0-1.2 (777)	1.0-1.2 (XT01B)		1.4-1.6 (96)	
		1.2-1.4 (765)	1.2-1.4 (XT01B)	1.2-1.4 (XT03B)		

	MODELS	3300 GTO Suction	
		AIRCAPS	GTO EPA
		Transfer/System	65 % EPA
INDUSTRIAL BODYSHOP	Fillers	1.8 (EPA)	
	Basecoats	1.4-1.6 (EPA)	
	Clearcoats	1.6 (EPA)	
	Single stage paints and HS	1.6 (EPA)	
METAL INDUSTRY	Primers	1.8 (EPA)	
	Paints and Clears	1.6-1.8 (EPA)	
	Thick coats		
WOOD INDUSTRY	Silicates and abrasives		
	Dyes	1.4 (EPA)	
	Basecoats and sealants	1.8 (EPA)	
	Clearcoats	1.6-1.8 (EPA)	
GENERAL INDUSTRY	Pigmented clearcoats	1.6 (EPA)	
	Adhesives		
	Ceramics and abrasives		
	Paints for Plastic and Sofw	1.6-1.8 (EPA)	
Calorific	1.8 (EPA)		





3300 GTO Gravity			MINI XTREME		Classic Pro XD Gravity
GTO EPA 65 % EPA	GTO HVLP 72 % HVLP	GTO EVO 65 % EPA	MINI EPA 65 % EPA	MINI HVLP 75 % HVLP	CLASSIC PRO XD 65 % EPA 50% Conventional
1.6-1.8 (EPA) 1.4 (EPA) 1.4-1.6 (EPA) 1.6 (EPA) 1.6-1.8 (EPA) 1.6 (EPA) 2.2-2.8 (64S-62S)	1.6-1.8 (HVLP) 1.4 (HVLP)	1.3-1.4 (EVO) 1.4 (EVO) 1.4 (EVO)	1.2-1.3 (Mini EPA) 1.3-1.4 (Mini EPA)	1.2-1.3 (Mini HVLP)	1.6-1.8 (21EPA)
	1.8 (HVLP)	1.4 (EVO)	1.3-1.4 (Mini EPA)		1.6 (21EPA) 1.8-2.5 (21EPA-36) 1.6 (21EPA) 2.0-2.8 (25-28) 2.0-2.8 (25-28)
1.2-1.3 (EPA) 1.8 (EPA) 1.6 (EPA) 1.4-1.6 (EPA) 2.0-2.5 (64S)	1.2-1.3 (HVLP) 1.8 (HVLP)	1.4-1.6 (EPA) 1.3-1.4 (EVO)	1.0-1.2 (Mini EPA) 1.4 (Mini EPA) 1.3 (Mini EPA)	1.2 (Mini HVLP)	1.8-2.0 (21EPA-25) 1.4-1.8 (21EPA)
1.4-1.6 (EPA) 1.4-1.6 (EPA)		1.3-1.6 (EVO) 1.4 (EVO)	1.3-1.4 (Mini EPA) 1.3-1.4 (Mini EPA)	1.3-1.4 (Mini HVLP) 1.3-1.4 (Mini HVLP)	2.0-2.5 (25-36) 2.0-2.8 (25-28)



4100 Xtreme	MINI XTREME		3300 GTO PRESSURE		
EPA 65 % EPA	MINI B EPA 65 % EPA	MINI B HVLP 75 % HVLP	Medium Pressure 55% Medium Pressure	EPA 65 % EPA	HVLP 72 % HVLP
1.8 (XT01) 1.4 (XT01) 1.6 (XT01)	0.8 - 1.0 (Mini EPA) 1.0-1.2 (Mini EPA)	0.8 - 1.0 (Mini HVLP) 1.0 - 1.2 (Mini HVLP)	1.4 (765)	1.4 (EPA)	1.4 (HVLP)
1.8 (XT01) 1.6 (XT01)	1.2 (Mini EPA)		1.6-1.8 (765) 1.4 (765) 2.2-2.5 (64) 2.5-2.8 (67-62)	1.4-1.6 (EPA) 1.2-1.4 (EPA)	1.4 - 1.6 (HVLP)
1.4 (XT01) 1.6 (XT01) 1.6 (XT01)	0.8-1.0 (Mini EPA) 1.0 (Mini EPA) 1.0 (Mini EPA)	0.8-1.0 (Mini HVLP) 1.0 (Mini HVLP)	1.4-1.6 (765)	1.4-1.6 (EPA) 1.2-1.4 (EPA)	1.4-1.6 (HVLP)
1.4-1.6 (XT01)	1.0-1.2 (Mini EPA)	1.0-1.2 (Mini HVLP)	1.2-1.8 (20) 1.6-2.8 (67-62)		

APPLICATION GUIDE
MIX AND AIRLESS SPRAY GUNS



	MODELS	HIGH PRESSURE MIX / AIRLESS GUNS			
	AIRCAPS	Xtreme Mix	Mini Xtreme Mix	PSAM 107	PSAM 104
Wood and Metal	Varnishes, clearcoats, colours	0.011"-0.013"	0.011"-0.013"	0.011"	0.011"
	Undercoats, sealing primers, primers	0.011"	0.011"	0.011"-0.013"	0.011"-0.013"
	Waterbased clearcoats and varnishes Forge effect	0.011"-0.013"	0.011"-0.013"	0.011"-0.013"	0.011"-0.013"
Wall and ceiling coverings	Plastic paints			0.017"-0.021"	0.017"-0.021"
	Multicoloured				
	Waterproof, fireproof Gotelé Coarse gotelé, Stone pastes, Pastes			0.021"-0.026"	0.021"-0.026"



INDUSTRY EQUIPMENT
APPLICATION GUIDE

MODELS		Pneumatic Low Pressure			Pneumatic Mix			Mix
AIR CAPS		DM 1/300	DM 1/400	DM 2K	Mack 150 Mix	Mack 320 Mix	Raider 300 Mix	HTV 250
TECHNICAL DETAILS	Inlet	7 bar max.	7 bar max.	7 bar max.	7 bar max.	7 bar max.	7 bar max.	7 bar max.
	Consumption	380 L/min.	580 L/min.	580 L/min.	245 L/min.	610 L/min.	370 L/min.	448 L/min.
	Size	650x600x950 mm.	650x600x950 mm.	650x600x950 mm.	480x470x875 mm.	480x470x875 mm.	415x390x745 mm.	465x460x875 mm.
	Weight	16 Kg.	18 Kg.	21 Kg.	28 Kg.	30 Kg.	15.5 Kg.	30 Kg.
	Maximum Pressure	6 bar	7 bar	7 bar	91 bar	226 bar	200 bar	175 bar
	Maximum Flow	30 L/min.	40 L/min.	40 L/min.	2.7 L/min.	2.7 L/min.	2.7 L/min.	2.54 L/min.
	Maximum tip				0.018"	0.018"	0.013"	0.018"
COMPLEMENTS	SPRAY GUN	4100 Xtreme Mini Xtreme B HVLP/EPA V4/V5/V6			Mini Xtreme Mix/403 Mix			Mini Xtreme Mix V7 Mix /4041 Mix
	HOSES	air + product aerographic hose 5m 86463818 10m 86463819			air + product hose 5 m. 86463804 10 m. 86463805			Mix hose air + product 7 m. 86463869
	Nozzle/Tip	According to application			Tip mix Standard 814 605 XX			Tip Extra Finish 814 612 XX
App. INDUSTRIAL	Shop Primer	X	X	X				
	Primer averages	X	X	X				
	Thick Coat Primers							
	Zinc Primers	X	X	X				
	Single stage	X	X	X	X	X	X	X
	Enamels	X	X	X	X	X	X	X
	Clearcoats	X	X	X	X	X	X	X
Glues, adhesives	X	X	X					
App. WOOD	Dyes	X	X	X	X	X	X	
	Basecoats	X	X	X	X	X	X	X
	Clears	X	X	X	X	X	X	X
	Pigmented clearcoats	X	X	X	X	X	X	X
	Waterborne clears	X	X	X	X	X	X	X

APPLICATION GUIDE
CONSTRUCTION EQUIPMENT



MODELS		Mix Pneumatic	Airless Pneumatic	Electric Airless			
AIRCAPS		Raider 160	Raider 260	Atlanta 200 Plus	Atlanta 500	Atlanta 800	Atlanta 800G
TECHNICAL DETAILS	Inlet	6 bar max.	6 bar max.	220v/50Hz	220v/50Hz	220v/50Hz	Petrol
	Consumption	200L/min	200L/min	1.0 HP	2.0 HP	2.9 HP	5,5 HP
	Size	420x450x850mm	420x450x850mm	420x250x630mm	650x400x600	1,100 x 750 x 900 mm	1100 x 750 x 900 mm
	Weight	17 Kg	17 Kg	27 Kg	53 Kg	72 Kg	
	Maximum pressure	96 bar	156 bar	180 bar	220 bar	220 bar	220 bar
	Maximum flow	1.5 L/min	1 L/min	2 L/min	5 L/min	9L/min	8,5L/min
	Maximum tip	0.013"	0.013"	0.018"	0.026"	0.032"	0.036"
ACCESSORIES	SPRAY GUN	Xtreme Mix	PSAM 104 / 107	PSAM 104 / 107	PSAM 104 / 107	PSAM 104 / 107	PSAM 107
	HOSES	Mix air+product 5m 86463804	Airless Standard 5m 86463826	Airless Dispersions 10m 864 638 02	Airless Dispersions 10m 864 638 02	Airless Dispersions 10m 864 638 02	Airless Dispersions 10m 864 638 02
	Product TIP	Standard mix tip 814 605 XX	Rotating Airless tip 814 611 XX	Rotating Airless tip 814 611 XX	Rotating Airless tip 814 611 XX	Rotating Airless tip 814 611 XX	Rotating Airless tip 814 611 XX
CONSTRUCTION applications	Undercoats/Primers	X	X	X	X	X	X
	Varnishes	X	X	X	X	X	X
	Clearcoats	X	X	X	X	X	X
	Plastics				X		X
	Chlorinated rubber					X	X
	Waterproof				X	X	X
	Fireproof			X	X	X	X
	Bituminous					X	X
	Thick epoxy coat					X	X



Bellows pumps			Pneumatic Airless				Electrics Airless		
HT 10	HT 15	HT 25	Raider 300	Mack 320	Mack 400	Mack 600	Atlanta 200 Plus	Atlanta 500	Atlanta 800
6 bar max.			7 bar max.	7 bar max.	6 bar max.		220v/50Hz	220V/50Hz	220V/50Hz
646 L/min.	800 L/min.	1,326 L/min.	370 L/min.	610 L/min.	1,500 L/min		1 HP	2 HP	2,9 HP
575x525x875 mm.			415x390x745 mm.	480x470x875 mm.	545x546x1,007 mm.		420x250x630 mm.	650x400x600 mm.	
41 Kg.	42 Kg.	48 Kg.	15,5 Kg.	30 Kg.	62 Kg.	63 Kg.	27 Kg.	53 Kg.	72 Kg.
60 bar	90 bar	150 bar	200 bar	226 bar	240 bar	360 bar	180 bar	220 bar	220 bar
9.75L/min.			2.7 L/min.	2.7 L/min.	7.2 L/min.	5.2 L/min.	2 L/min.	5 L/min.	9 L/min.
0.018"			0.013"	0.018"	0.032"		0.018"	0.026"	0.043"
Mini Xtreme Mix V7/4041 Mix			PSAM 104/107/110				PSAM 104/107/110		
Mix hose air + product 10 m. 86463805			Standard airless hose 10 m. 86463804 15 m. 86463805				Airless dispersions hose 10m 86463802	Airless dispersions hose 10m 86463802 15m 86463803	
Tip Extra Finish 814 612 XX			Tip Airless swivelling 814 611 XX Rotating head 81461101				Tip Airless swivelling 814 611 XX Rotating head 81461101		
			X	X	X		X	X	X
				X	X				X
X	X	X	X	X	X		X	X	X
X	X	X	X	X	X		X	X	X
			X	X	X				
X	X	X	X	X	X		X	X	X
X	X	X	X	X	X		X	X	X
X	X	X	X	X	X		X	X	X



MEXICO

Calle 2 · Número 5C · Bodega 6
Parque Industrial Benito Juárez
C.P. 76120 Santiago de Querétaro
(Querétaro) MEXICO

Tel.: (+52) 442 388 5099
sagolamexico@sagolamexico.mx
www.sagolamexico.mx

COLOMBIA

Calle 30a · Número 6-22 · Piso 32
C.P. 110311 Bogotá COLOMBIA
Tel.: (+57) 1 - 7 43 68 30
sagolacolombia@sagolacolombia.co
www.sagolacolombia.co

SAGOLA 

SPAIN

Urartea, 6 · 01010
Vitoria-Gasteiz (Álava) SPAIN
Tel.: (+34) 945 214 150
sagola@sagola.com
www.sagola.com

